

concrete DECOR®

Vol. 18 No. 8

November/December 2018

concretedecor.net

**New museum
puts Texas
on the map**



MCKINNON MATERIALS, INC.

WE'VE GOT YOU COVERED!

EPOXIES

- Stone Bond
- Cool Weather
- Cold Weather
- UV

Reseal

Tinted Industrial

Clear Industrial

Rapid Set

Primer

Rubber

EZ Coat

Water-Borne

SEALERS

High Performance Urethane

Polyaspartic

Miracle Glaze H2O

Crystal Coat

Vinyl Supreme

50,000 sq. ft. of epoxy ready to ship in 24 hours or less

Largest In-Stock Epoxy and Stone Selection



River Rock (as low as 32°)



Crystal Coat



McKrete



Chromastain™



Industrial Epoxy



Aurora Epoxy

concrete DECOR®

November/December 2018
Volume 18 · Issue No. 8

Publisher: Bent O. Mikkelsen
bent@protradepubinc.com
(877) 935-8906 x201

Editor: Stacey Enesey Klemenc
stacey@protradepubinc.com
(757) 427-6355

Creative Director: Bill Simpson
bill@protradepubinc.com
(877) 935-8906 x203

Web Design: Joshua Johnson
joshua@protradepubinc.com
(877) 935-8906 x206

Writers: Jeff Bonkiewicz
Lindsay Chelf
K. Schipper
Jahn Stopperan
Chris Sullivan
Rick Yelton

Business Manager: Sheri Mikkelsen
sheri@protradepubinc.com
(877) 935-8906 x205

Circulation: Meg Webb
meg@protradepubinc.com
(877) 935-8906 x200

Sales: Bent O. Mikkelsen
bent@protradepubinc.com
(877) 935-8906 x201

Subscriber Services: (877) 935-8906 x200
circulation@protradepub.com
Fax: (541) 228-9972

Mailing Address: Professional Trade
Publications Inc.
27495 2nd Place
Junction City, OR 97448

Concrete Decor™ is published eight times a year by Professional Trade Publications Inc. Bulk rate postage paid at Lebanon Junction, Kentucky, and additional mailing offices.

ISSN 1542-1597

© 2018 Professional Trade Publications Inc. All rights reserved. Acceptance of advertising in this magazine and mention of specific products or services in editorial content does not imply endorsement of the product or service by *Concrete Decor*. No part of this publication or its website may be reproduced without written permission of Professional Trade Publications Inc.



Publisher's Letter



Dear Readers,

2019 is gearing up to be an action-packed year for *Concrete Decor*.

We will start off the year at World of Concrete by hosting the much-anticipated Decorative Concrete LIVE! event outdoors across from the entrance to the South Hall at the Las Vegas Convention Center. The space will include an entirely new floor plan along with new focuses on using concrete for improved energy efficiency in construction.

Artisans from abroad and across the U.S., Canada and Mexico will also be on hand conducting live demos throughout the week. An array of innovative applications and live demonstrations will showcase the products, the tools and the best-kept secrets in decorative and architectural concrete.

Also, in 2019 the Concrete Decor RoadShow will be upping its pace with events at supply stores and at regional events. Keep an eye on our schedule of events in the pages of *Concrete Decor* and online at www.roadshow.concretedecor.net for dates and locations.

This coming Oct. 28-31 the now biennial Concrete Decor Show will take place at the Arlington Convention Center in Arlington, Texas. Here, too, *Concrete Decor* will focus not just on the best in new product innovations, great education and networking events, we will also emphasize the energy efficiencies of using concrete products. It's part of our effort to advance the use of concrete throughout the building process while also showcasing ways concrete products answer the call for sustainability and decor in the restoration markets.

In the meantime, *Concrete Decor* is working on numerous stories for 2019 that will inspire and help your company profit, drive home the fact that decorative concrete is a proven and preferred solution over other building materials and overall a fun industry to be part of.

Lastly, I encourage you to patronize the companies that advertise with *Concrete Decor*. They are critically important to making sure the magazine provides the type of industry insights you need to succeed.

If you are not already subscribing to *Concrete Decor* magazine's e-newsletter, go online to www.concretedecor.net and get that free service started. Like us on Facebook, and follow us on Instagram and Twitter so you can stay abreast of our announcements throughout the year.

Now in our 19th year, *Concrete Decor* looks forward to serving you with the best and most reliable industry content.

Sincerely,

Bent Mikkelsen
Publisher

On the cover: To commemorate San Felipe de Austin, an Anglo colony that greatly contributed to Texas' history, the Texas Historical Commission had a 10,000 square-foot state-of-the-art museum built that included meticulous maps polished to perfection.

Photo courtesy of Jeff Bonkiewicz



Find us on Pinterest
[/concretedecor1](https://www.pinterest.com/concretedecor1/)



Follow us on Twitter
[@concretedecor](https://twitter.com/concretedecor)



Like us on Facebook
[/ConcreteDecorMagazine](https://www.facebook.com/ConcreteDecorMagazine/)



Tag us on Instagram
[@concretedecormag](https://www.instagram.com/concretedecormag)

concrete DECOR®

Vol. 18, No. 8
November/December 2018



INDUSTRY NEWS

- 4 Toronto: Concrete Decor LIVE! makes its debut**
- 5 Concrete Power**
Decorative Concrete LIVE! switches on Jan. 22-25, 2019

THE BROADCAST

- 6 Grow Engagement with Quote Images**
by Lindsay Chelf



ARTISAN IN CONCRETE

- 12 Jeremy Bayliss**
DelRailey Designs, Dothan, Alabama
by Stacey Enesey Klemenc

- 1 PUBLISHER'S LETTER
- 3 ADVERTISERS
- 8 PRODUCT NEWS
- 39 MARKETPLACE



PROJECT PROFILE

- 16 Museum Blends History with Multiple Processes and New Concrete Products**

San Felipe de Austin State Historic Site museum, San Felipe, Texas

by Jeff Bonkiewicz

FEATURES

- 20 Installing heated concrete countertops**
by Jahn Stopperan
- 24 Specialty fibers weave their way into more decorative projects**
by Rick Yelton
- 28 Proper Testing Can Pinpoint Moisture Problems**
by K. Schipper
- 32 Better Safe Than Sorry**
Proper PPE is a must on today's job site
by K. Schipper

CONCRETE QUESTIONS

- 36 Compression vs. Adhesion:**
What's more important when testing decorative overlays?
by Chris Sullivan

FINAL POUR

- 40 Out of the Blue**
by Stacey Enesey Klemenc





Jeff Bonkiewicz, sales and marketing manager for Laticrete International, is responsible for the company's sales and marketing tools, trade shows, customer trainings, content development, digital promotions and sales management. Jeff can be reached at jsbonkiewicz@laticrete.com. See Jeff's article on page 16.



Lindsay Chelf is the marketing coordinator at Constructive Communication Inc. With almost a decade of experience in writing and editing for publication, her specialty is the use of graphic design, video and social media in marketing for the architecture, engineering and construction industry. Chelf can be reached at (614) 541-9868 or at lchelf@constructivecommunication.com. See Lindsay's article on page 6.



Jahn Stopperan, president of DG Innovations LLC, is a senior marketing and product development consultant for OEMs in the flexible heater and flexible electronics industry. Jahn provides companies with expertise and strategic guidance in consumer, industrial, military, aerospace and medical markets for electronic and thermal solutions. He can be contacted at jstopperan@dginnovationsllc.com. See Jahn's article on page 20.



Chris Sullivan is vice president of sales and marketing with ChemSystems Inc. and a member of the Decorative Concrete Hall of Fame. He has led seminars and product demonstrations throughout North America. Reach him at questions@concretedecor.net. See Chris' column, "Concrete Questions," on page 36.

BDC Supply Co.	39
Butterfield Color	37
Concrete Polishing HQ	39
Concrete Polishing HQ	Back Cover
Fox Blocks/Airlite Plastics Co.	25
Franmar Chemical	39
GranQuartz	31
Hi-Tech Systems	17
HTC (Husqvarna)	7
Husqvarna Construction Products	15
Jiffy Mixer Co. Inc.	23
Laticrete International Inc.	19
Mapei	Inside Back Cover
McKinnon Materials	Inside Front Cover
Pacific Concrete Images	39
Prep Tech Systems	9
Ralston Concrete/Pacific Palette (Sparkle Grain)	39
Redi-Mix Colors	27
Sika Scofield	11
Solomon Colors/Brickform	21
Spin Screed Inc.	35
Super-Krete Products/ICP Construction	9
Tramex Ltd.	29
Trinic LLC	23
Versatile Building Products/Garage Coatings ..	21
Wagner Meters	3
Wagner Meters	39
Water Cannon	39
World of Concrete/The Buildings Show	38

For information from any of these advertisers, go to connect.concretedecor.net/PIRC

IT'S TIME TO CELEBRATE!

NOW 24 HOURS!

RAPID RH® is:

- Easiest to Comply with ASTM F2170
- 10 Times FASTER
- Lowest Cost/Test
- Simplest to Use

SAVE MORE TIME AND MONEY WITH RAPID RH® • CALL NOW 800.207.2164

Major Change to ASTM F2170!

Measuring moisture in concrete floor slabs now takes just 24 hours for the final reading, not 72 hours. But only with relative humidity (RH) testing -- known for its unmatched speed, accuracy, and reliability.

RH testing with the Rapid RH® just got faster -- a lot faster! ASTM F2170 guidelines have been updated, shaving two full days off the required test time for final readings. You can make important project decisions quickly with confidence as always. Final readings come two days sooner, saving both time and money. No similar ASTM update is expected for other concrete test methods.

The choice is clear. If you're looking for a concrete moisture test that's FAST, accurate, and reliable, choose Rapid RH®.

For more information about the new RH test guidelines, call 800-207-2164 or visit www.RapidRH.com.



Toronto: Concrete Decor LIVE! makes its debut

TO showcase both the durability and beauty of decorative and architectural concrete, Concrete Decor LIVE! is making its debut at The Buildings Show in Toronto, Ontario, Canada. Between 10 a.m. and 5 p.m. Nov. 28-30, 2018, artisans will demonstrate how colors and textures on concrete not only speed the building process but also reduce the need for traditional building finishes in new construction or rehabs.

Demonstrations will be held during show hours throughout the day alongside static displays of horizontal

and vertical concrete finishes that can be used in quality commercial settings, public spaces, and homes of any size and style.

Floor treatments will include the increasingly popular polished concrete, as well as stamped concrete and a trowel-finished stained-and-sealed application. Artisans will also be on hand to demonstrate a variety of overlay installations including metallic epoxies, microtoppings and waterproofing systems that complement decorative concrete.

Walls will be finished with a variety of products and techniques to highlight concrete's chameleon-like qualities. Artisans will carve vertical surfaces to resemble stone, stamp and color walls to replicate wood planks, and spray an application that mimics a brick/mortar veneer. Static displays will feature sitting walls with caps and partially finished walls exhibiting lathe and various surface prep techniques.

For more information about Concrete Decor LIVE! call (877) 935-8906 or visit www.concretedecor.net. 📱

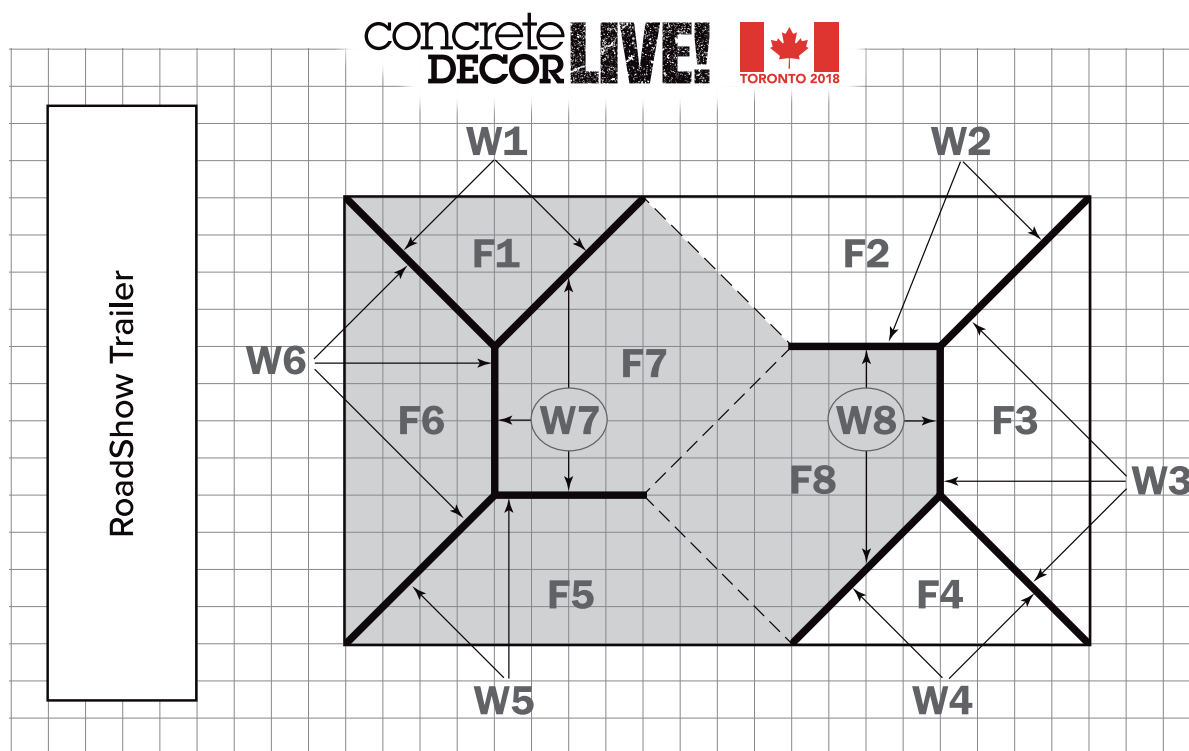

The gray section of the demo space will be poured concrete. The white area will be plywood substrate used for overlay applications.

Floors

- F1** Stamped concrete
- F2** Decorative microtopping
- F3** Waterproofing decorative concrete application
- F4** Stamped overlay
- F5** Polished concrete
- F6** Trowel finish for acrylic stain & seal application
- F7** Metallic epoxy application
- F8** Polished concrete

Walls

- W1** Carved stone
- W2** TBA
- W3** Partial finish showing lathe and surface prep
- W4** Sitting walls with caps
- W5** Spray applied brick/mortar veneer
- W6** Stamped wood plank application
- W7** TBA
- W8** TBA



Concrete Power Decorative Concrete LIVE! switches on

Jan. 22-25, 2019

THE third annual Decorative Concrete LIVE! will be all systems go Jan. 22-25 during the upcoming World of Concrete 2019 in Las Vegas. Situated in the Silver Lot across the street from the South Hall, this year's exhibit will spotlight the power of concrete through an array of cutting-edge construction applications.

The 2019 showcase will identify how decorative and architectural concrete can be used to satisfy the requirements of an increasingly energy-minded society. Throughout the show, interactive demonstrations will focus on energy-efficient building construction techniques that can be used on retail, public works, residential and commercial projects.

The benefits of building with insulated concrete forms (ICFs) will be shown through various configurations. Durable inside and out, the reinforced concrete building components can be clad with an array of exterior finishes attendees can see and feel. Artisans will use these materials to replicate traditional-looking finishes such as brick and stone, as well as apply finishes that have their own unique look.

Pervious concrete will also be part of the upcoming year's show. Knowledgeable professionals will be on hand to explain the many ways this porous material can help reduce stormwater runoff and recharge groundwater.

Decorative Concrete LIVE! will also show how decorative concrete construction materials and techniques can be blended with other energy-saving features on commercial and residential projects.

For more information on how you or your company can become involved with Decorative Concrete LIVE! in 2019, call (877) 935-8906. 🖋️



LASSO the DATE!

The Concrete Decor Show returns to the Lone Star State

Dust off your cowboy hat and get ready to head to the leading educational conference and trade show dedicated to architectural and decorative concrete.

The **Concrete Decor Show** in 2019 will round up state-of-the-art exhibits and product demonstrations. If it's hands-on learning you're after, you can't miss with targeted workshops led by world-class educators.

And for the bookish, you can sit back and soak up lively panel discussions and thought-provoking seminars taught by some of the industry's best construction professionals.

Sign up for email updates at ConcreteDecorShow.com



concrete ²⁰¹⁹
DECOR SHOW
ARLINGTON

October 28-31, 2019

Arlington Convention Center
1200 Ballpark Way
Arlington, Texas

(Cowboy hat not absolutely necessary.)

Grow Engagement with Quote Images

by Lindsay Chelf

YOU have likely heard by now that sharing visual content — infographics, photographs and videos — on social media garners attention, builds brand awareness and increases audience engagement better than text-only posts. Even if you have already taken those first steps into creating or distributing original visual content on your company’s social media platforms, it can be overwhelming to continually plan and develop new pieces. Enter the time-saving and easy (yet still powerful) quote images.

Quote images are successful due to their blend of two different types of highly shareable content: quotes (or other short blurbs of text) and images. Extremely popular on visual-based networks, such as Instagram and Pinterest, quote images also perform well on Facebook and Twitter. While they aren’t as content-driven as a video or infographic, and are more of a “surface” form of engagement, they are simple and can be produced quickly.

Before you start creating your own, however, ask yourself what your goals are with quote images. Do you want more visibility for your brand? Do you want to generate discussion? Do you want to drive people back to your website? Make sure that whatever you create is done with your objective in mind.

There are countless online sources for quotes, such as www.brainyquote.com, www.goodreads.com or Pinterest. There are also excellent stock image websites, such as www.pexels.com, though using your own photographs further strengthens your brand.

Test the waters with a couple of quote images, and see how the number of comments, likes, retweets and shares differ from other types of posts you make. 📱

Lindsay Chelf is an account manager at Advancing Organizational Excellence (AOE) – a full-service association management and marketing firm serving the concrete industry (www.aoeteam.com). With more than a decade of experience in writing and editing for publication, her specialty is the use of graphic design, video and social media in marketing for the architecture, engineering and construction industry. Chelf can be reached at lindsay.chelf@aoeteam.com.

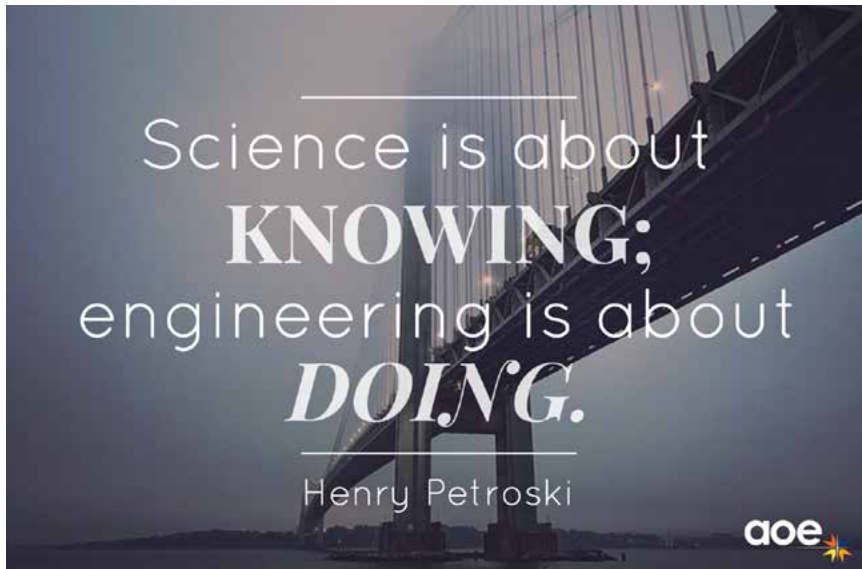

Images courtesy of Advancing Organizational Excellence

What kind of content does well in the quote image format?

Quotes: The obvious option! People are inspired and entertained by good quotes and will share ones they find relatable. Size up your followers and determine what type of quotes would best grab their attention.

For example, if your target audience is construction workers in the field, sayings about hard work and craftsmanship will likely perform better than quotes from famous CEOs about leadership. Or, demonstrate your involvement in your industry by attending a conference and turning a quote from the speaker into an image.

more about your industry, or you as a company or organization. For employees or members, they can create a feeling of community or pride, and they may be inclined to share the stat on their personal social media accounts as well.



Testimonials: While they may not be as shareable as quotes or statistics, testimonials give you credibility. People are more likely to stop and read what your happy customers and clients have to say when it’s in the form of an image with words superimposed on it rather than a block of text.



Statistics: Compelling and to the point, stats can be an excellent way to invite your followers to know

DURATIQ™ 5

Ultra-compact DURATIQ™ technology



Power meets versatility

The DURATIQ 5 is a floor grinder with unmatched versatility for professional users. With its ultra-compact size, it's a powerful tool for all types of grinding jobs in various environments, but without compromising on DURATIQ's high performance technology.

Whether the job requires grinding away a stubborn coating, smoothing a wood parquet floor or transforming a concrete floor into a high-gloss HTC Superfloor™, The DURATIQ 5 is up to the task. With a grinding width of 22.4 in (515 mm) it is best suited for small to mid-size projects.

Experience a machine that combines power and versatility with unmatched ergonomics.

htc-floorsystems.com

order@htc-america.com Phone: 865-689-2311

© 2018 HTC, Inc. All rights reserved.



Cordless hammer drill made for speed

When it comes to drilling in concrete for anchors, the new Hilti cordless rotary hammer drill TE 6-A22 is made for speed.

It includes a chiseling feature for light-duty corrective chipping. When paired with the TE DRS 6-A T1 Dust Removal System, it provides an OSHA 1926.1153 Table 1-compliant solution for dust control when drilling into concrete.

The hammer drill is backed by Hilti's 20/2/1 year warranty – 20 years of repair or replacement of defective parts; two years no-cost repair including wear and tear; and a one-day turn-around on repairs.

www.hilti.com
(800) 879-8000



Edger finishes wall tops in one pass

Bon's Double Edger features two radius sides to finish wall tops in one pass. This edger is available in three sizes, 6-by-3; 6-by-4 and 8-by-6 inches. Each cuts a 3/8-inch radius edge on one side and a 1/8-inch radius cut on the other side.

This double-sided tool — useful for walls, forms or curbs — features Bon's Comfort Wave handle. The patented handle has a unique arched back and finger wells for a comfortable, secure grip.

www.bontool.com
(800) 444-7060

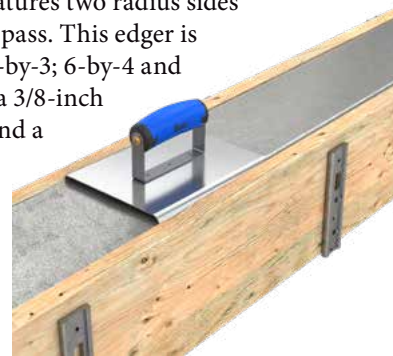

Adhesive anchor system is ideal choice

The Euclid Chemical Co. has launched Dural ICC Gel, a new adhesive anchoring solution with enhanced temperature and creep resistance capabilities that can be used across all areas of a building.

Touted to be one of the most highly engineered and extensively tested two-component, hybrid adhesive anchors available, the gel is an ideal choice for large-scale construction and infrastructure projects. It ensures that threaded rods and rebar are firmly attached to the concrete and that concrete will bond effectively to concrete.

The standards to which Dural ICC Gel has been analyzed and approved include the International Code Council (ICC-ES Report 4255) and NSF/ANSI Standard 61, as well as many state transportation departments.

The gel's creep resistance is one of its key attributes. Creep is the tendency of a solid material to move slowly or deform under the influence of heat or applied loads. However, the gel avoids creep effects even when subjected to heavy loads and sustained temperatures of up to 180 degrees F.

When the minimum installation temperature and the maximum short-term loading temperatures are considered, this product has a wide approved use range. It will maintain its anchoring abilities at both ends of the temperature range, with a range that goes as low as 5 degrees F and as high as 302.

This versatility is exemplified by the fact that the gel will consistently perform in extreme work conditions such as dry, wet and water-filled concrete or when being applied into drilled holes that are underwater. This combination of resistance and application properties ensures rapid bolt-up times and high productivity all year-round. It cures in only 45 minutes.

www.euclidchemical.com
(800) 321-7628

Paddle mixer delivers fast mix times

Blastcrete Equipment LLC, a long-time manufacturer of shotcrete and guniting mixers and pumps, now offers a refractory paddle mixer that delivers fast mix times while working with mixtures that include aggregates up to a half-inch (13 millimeters) thick. The hydraulic machine mixes as much as 500 pounds (227 kilograms) of refractory castable in about two minutes and performs well in form-and-pour jobs and other applications involving precast shapes, mortars and grouts.

The mixer's oversized, heavy-duty, chain-and-sprocket drive system provides years of reliable use under harsh conditions.

It also features a pair of easily accessible levers to control the hydraulic dump and operate the system in both forward and reverse.

Customers can pair the 1,900-pound (862-kilogram) machine with a variety of electric power options for safe indoor use and to meet global needs. Customers have their choice of three electric motors: a 10-horsepower (7.5-kilowatt) electric motor with starter disconnect, a 240- or a 480-volt, 60-hertz motor, or a 380-volt, 50-hertz motor. Customers also can choose to power the paddle mixer with a 14-horsepower Kohler gas engine.

The 4-foot-wide (1.2-meter-wide) mixer's trailer features a single axle for easy towing, or it can be skid-mounted.

Customers can use the paddle mixer with Blastcrete's patented DustAway system, which consists of an innovative bulk bag design that attaches to the mixer to contain dust as the mixer fills. DustAway helps businesses meet OSHA crystalline silica dust regulations by controlling dust to within OSHA-permissible exposure limits.

For larger refractory jobs, Blastcrete also offers a 1,000-pound refractory paddle mixer-pump, the RMX-5000 and a refractory pan mixer that can mix as much as 2,200 pounds in less than two minutes.

www.blastcrete.com
(800) 235-4867



Densifier prolongs concrete's life

Coatings for Industry has released WearCoat 3020, a new water-based lithium silicate concrete densifier that helps polished concrete floors last longer while maintaining an excellent look.



This new product is water-based and compliant with all VOC regulations, yet offers excellent adhesion to porous concrete, greatly reducing surface dusting as it facilitates polishing. It permanently bonds with concrete upon contact, filling the pores and improving its resistance to water, chemicals and abrasion.

The resulting surface provides high traction for safety, yet has a glossy, nonyellowing finish that can even improve with age. Most importantly, WearCoat 3020 helps prolong the life of the concrete, as it resists damage from salt, water and ultra-violet light intrusion.

WearCoat 3020 complies with all VOC regulations as it contains less than 10 g/l VOC. It has little or no odor during and after application. It is also nonhazardous for transport, so it can easily be delivered by any common carrier, even overnight.

This densifier is a single-component product, sold in one- and five-gallon containers. It offers a fast cure time — dry to touch in under two hours, light foot traffic in four to six hours, and ready for vehicles or polishing in 24 hours.

www.cfcoatings.com
(215) 723-0919

Admixture increases concrete's strength

BASF recently introduced Master X-Seed 55, a first-of-its-kind, strength-enhancing admixture that improves both early- and late-age strength development in concrete. It was initially launched in Europe in 2009 and gained such widespread success that BASF developed a unique formula specifically designed for North America.

The formula is a stable suspension of synthetically produced crystalline calcium silicate hydrate nanoparticles that facilitate the growth of CSH crystals between cement grains and improve the overall hydration of portland cement. The technology's strength-enhancing property permits a reduction in the total cementitious material content of a given concrete mixture while maintaining the concrete's compressive strength.

Master X-Seed 55 admixture provides a strength safety factor, permits earlier stripping of forms and promotes sustainable construction. It's recommended for use in ready-mixed and precast concrete, environmentally preferred concrete and self-consolidating concrete.

www.master-builders-solutions.basf.us

Why pay for a full grinder? **\$0 Down** **No Payment** for 90 days*

Introducing the revolutionary Interchangeable Grinding System by Prep Tech Systems. Easily swap heads and frames. Grow your fleet on your schedule and budget.



Patent Pending



Find out more

preptechsystems.com ♦ (888) 487-7371

*Based on approved credit application



MAKE YOUR SURFACES SMOOTH

Formulated especially for micro-topping, Micro-Bond™ is a cementitious product that contains extremely fine materials to create an ultra-smooth finish. Micro-Bond is the smart solution for repairing and resurfacing interior concrete floors, countertops and decorative art surfaces.

BENEFITS INCLUDE:

- Ready-mix formula (just add water)
- Easy application
- Superior bonding capabilities
- Highly versatile
- Simple finishing
- Textured finishes
- Easy to clean



ALSO AVAILABLE IN WHITE

LEARN MORE ABOUT OUR DECORATIVE PRODUCTS AND SYSTEMS @ WWW.SUPER-KRETE.COM



800.562.4921 • www.super-krete.com | www.icp-construction.com
Super-Krete® Products is a brand of ICP Construction. © 2018 ICP Construction. All Rights Reserved.



Water-jet tool roughens concrete surfaces

Aquajet Systems AB, a company that makes hydrodemolition machines, recently launched the Rotolance 1000 and Rotolance 2500. The powerful tools work in conjunction with Aquajet's Aqua Cutter 710 hydrodemolition robots as well as the Aqua Spine and Aqua Frame to deliver water pressures in excess of 36,000 psi through a specially designed pattern of nozzles.

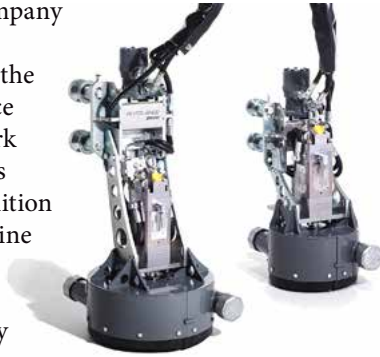

The Rotolances effectively clean, remove and roughen concrete surfaces, leaving a better bonding surface for new concrete or alternative materials. They can be used for applications including roads, bridges, airports, harbors, sewage pipes and water reservoirs.

Contractors also can use Rotolances to remove rubber coatings, paint, rust, plastic and other materials. It serves as a light-removal alternative to Aqua Cutter robots meant to remove deeper sections of concrete.

The attachment can be operated around the clock due to its computer-controlled automation.

Hydrodemolition uses high-pressure water jets to precisely remove sound, deteriorated or damaged concrete. The sustainable method leaves rebar undamaged while protecting and preserving existing concrete. The method eliminates vibrations that cause microfracturing and minimizes exposure to harmful silica dust. Hydrodemolition also leaves a uniformly scarified surface ready to accept new material.

Both Rotolance models can cover a surface diameter as wide as 14 inches. Their removal method creates no dust pollution as the attachments make sand blasting unnecessary. The attachments feature unique ceramic nozzles specifically designed for demanding hydrodemolition applications. The nozzles last 300-350 hours, depending on the water quality.

Both models weigh about 242 pounds (110 kilograms) and easily attach to Aquajet's 710 Aqua Cutter hydrodemolition robots.

www.aquajet.se

14 new products added to line

Laticrete, a leading manufacturer of construction solutions for the building industry, has expanded its diverse family of Spartacote resinous flooring and decorative coating systems. The expansion includes 14 new products for a variety of commercial and industrial uses, all backed by the company's warranties.

The products are a semi, self-leveling epoxy topping; an epoxy membrane; a waterborne urethane primer and floor sealer; waterborne and high-build vertical coatings; cover gel, a general primer, an oil-tolerant primer, surface-build quartz and flake epoxies, an ultra violet- and chemical-resistant surface-build top coat; an epoxy fill coat; and surface-build pigments.

www.laticrete.com

Wet/dry vacuum is powerful, convenient

The Bosch GAS18V-3N Cordless Wet/Dry Vacuum Cleaner offers pro performance for cleanup just about anywhere without the need to plug in.



The 2.6-gallon vacuum offers sustained suction for up to 24 minutes of high-power vacuuming when using a Bosch 18-volt 6.0 Ah battery. The canister features Bosch's rotational airflow technology, which helps ensure consistent performance. Portable, handy and powerful, it weighs only 10.2 pounds, not including the battery.

The vacuum, which has a washable HEPA filter, delivers up to 51 cfm (cubic feet per minute) airflow and provides wet suction of up to a gallon and a half of water for disposal. It also features a complete set of attachments, including three extension tubes, a crevice nozzle and a floor nozzle, and on-board nozzle storage. Adapters for connecting the vacuum cleaner to various Bosch power tools and their dust hoods are available separately.

The wet/dry vacuum works with the Bosch 18-volt battery system, so it can clean up where there's no outlet by delivering up to four minutes of runtime per battery amp hour. The battery and charger are sold separately.

www.boschtools.com

(877) 267-2499

Hitachi is renamed Metabo

Hitachi Power Tools has changed its name to Metabo HPT for North America. The name change starts with the launch of the game-changing revolutionary MultiVolt platform. MultiVolt gives users the ability to choose either cordless or corded operation without sacrificing portability, power or performance.

MultiVolt tools can accept a 36-volt battery or plug into an outlet with their AC adapter. This unique platform offers the power of a corded tool, the freedom of a cordless platform and the choice to operate the tools cordless or corded. So, you can go cordless when you don't have access to power and need to move where the job takes you. When you do have access to power, save the battery for later and just plug in.

For your existing 18-volt tools, MultiVolt cordless batteries deliver 4.0 Ah of runtime at 36-volts in MultiVolt tools. They can also power Hitachi or Metabo HPT 18-volt cordless tools including cordless nailers. When the MultiVolt battery is used with the 18-volt tools, it generates an impressive 8.0 Ah of run time.

Current Hitachi power tool products will begin to transition to Metabo HPT after December 2018 and retain current brand identity: same color, same model numbers, same warranties and the same battery interchangeability.

www.metabo-hpt.com



New tools are battery driven

Milwaukee Tool recently released its M18 Fuel Hammer Drill, Drill/Driver and Impact Driver with a One-Key functionality. Through a ground-up redesign of the motor, mechanical and electrical components of these core tools, these drilling and fastening solutions achieve 60 percent more power, are up to two times faster and are more compact than their predecessors.

With the One Key function, contractors can easily use a mobile app to customize these tools for better control over power, speed and consistency — as well track and manage them in their inventory. Accessible within the app are a range of new features such as Anti-Kickback technology and a self-tapping screw mode that automatically shuts the tool off once a screw is seated.

Users can set their preferred task controls and, with the touch of a button on the tool, easily switch between saved tasks so each application is done with the most accurate and productive settings. Once the tool is set, a mobile device is no longer needed. Users can also access available setups based on common applications and materials.

Milwaukee's new M18 Fuel Hammer Drill, Drill/Driver and Impact Driver with One-Key are part of the M18 System, which now has more than 175 power tool products. They are part of the company's commitment to improving productivity by providing performance-driven and trade-focused solutions so users can perform an entire day's work on one battery system.

www.milwaukeetool.com

(800) 729-3878



Broomable overlay now can be finished smooth

The Top Cap you know and love from Kingdom Products can now be used to create a smooth finish. With this product, you can restore a standard broom finish or create a new smooth finish for staining and stenciling.

The one-component, low-build overlay makes it easy to revitalize existing concrete without expensive removal or replacement. After removing carpet or tile, you can use Top Cap to turn subfloor concrete into main flooring that will last many years.

Top Cap is suitable for interior or exterior use. It's engineered to stand up to a harsh freeze-thaw environment.

www.kingdom-products.com

Tool helps users with paving projects

GAF, a North American company that makes roofing components, pavement coatings and accessories, has launched a visualizer tool to help sell its StreetBond Pavement coatings. Created by Chameleon Power, the visualizer helps customers envision the outcome of paving projects prior to installation.

Users can select from a variety of coating colors and patterns and apply them to their project photos or drawings. The tool also features a "Need Ideas?" button that gives users some starting patterns and colors to help them decide.

The company maintains the tool shortens the design cycle and enhances customer satisfaction. Websites that use the visualizer enjoy increased user time of more than three times and sales closure rates of more than 75 percent.

www.streetbond.chameleonpower.com



Classic. Since 1915.

Your Partner in Decorative Concrete.



SCOFIELD SYSTEMS

1-800-800-9900

www.scofield.com

ARTISAN IN CONCRETE



Jeremy Bayliss DelRailey Designs, Dothan, Alabama

by Stacey Enesey Klemenc

YOU might say Jeremy Bayliss, owner of DelRailey Designs in Dothan, Alabama, is a colorful man. Literally. Out of all the decorative concrete services he offers to customers, he says, “Color sets me apart from everything else.”

He often blends powders to make custom colors and doesn’t like to constrict his colors to just those found on charts. “I throw colors down and I know what colors I can make with what,” he says. “That’s the artist in me.”

A jack of many trades

Bayliss, 38, who grew up in Wisconsin and Minnesota, was stationed at Fort Rucker in Alabama in the 2000s during his enlistment with the U.S. Army. In 2008, he was medically retired due to injuries from a motorcycle accident that left him 90 percent disabled. He decided to stay in the area.

Even before he was discharged



from the service, he was a professional painter doing residential and commercial jobs through his company, A Touch of Paint. Along with his painting gigs and mural commissions, he began to dabble in concrete coatings. Before long, the decorative concrete side of the business took off.

By 2009, he had founded DelRailey Designs, a company that offers decorative concrete services that

includes everything from concrete hardwood imitations and colorful metallic epoxy floors to hand-drawn rock patterns and air-brushed murals. “Concrete is a huge part of my business,” he says, “but it is just a part.”

He usually has four or five employees working for him, depending on the workload. Normally, he subcontracts the pouring portion of his jobs and concentrates on doing the decorative design. “Most of the time, my customers don’t even pick colors. They hire us because of my artist abilities,” he says. “We put it all together.”

In addition to doing concrete floors, he’s often hired to pair them with a mural on the wall. That’s another thing, he says, that makes him different from other concrete contractors in the area. “I have a background in art and I pull from that background in everything we do.”



Busted to Beautiful

DelRailey Designs — which Bayliss says was named after his young teenagers, Skyler del Rae and Dylan Riley — mainly uses Elite Crete products for its decorative work. That company’s Reflector Enhancer system, with the way Bayliss manipulates the color, is well received in the area, Bayliss says.

While the metallic look is very popular, stamped overlays are far and few between. “It’s a hard market in southern Alabama near a military base,” he notes. “There’s not big money here like there is in big cities. So I had to come up with other ways (to decorate concrete) that people around here could afford.”

One of those ways entails freehand-

drawn stone or wood patterns on existing cracked slabs that are overlaid with Elite Crete’s Thin Finish. “It’s allowed me to do more as far as looks go for less cost and with less product,” Bayliss says about the overlay that can breathe new life into old concrete. Plus, he adds, customers like the fact they have something unique that can’t be exactly duplicated.

Basically, he transforms an unsightly cracked patio or driveway by resurfacing, cutting and carving. He’s contemplating offering training on this method, which he calls Busted to Beautiful, as well as sharing his coloring techniques. He says Elite Crete is on board with this idea and he’s working on a plan to bring it to fruition.

For the dogs

Bayliss and his partner, Julian Ammons, who runs Lower Alabama Bully Cartel, an organization devoted to breeders of American Bully dogs, recently opened their combined headquarters in Hartford, Alabama. A bully named Loso (*below*) is Bayliss’ service



ARTISAN IN CONCRETE



dog and is alongside him when he goes out on jobs.

Bayliss also breeds, shows and trains the dogs — a mix of the American Pit Bull Terrier, the American Staffordshire Terrier and several bulldog-type breeds. Lovers not fighters, bullies are bred to be family companion dogs, he says.

The new headquarters, which includes a dog pool, features a showroom floored with concrete hardwood planks and Reflector Enhancer metallic epoxy. It also is walled with a variety of Bayliss's artwork including murals.

Sage advice

Bayliss has a bit of advice for those just breaking into the decorative

concrete business. "Always be open and honest with your customers and never cut corners," he says. "It's just not worth it in the long run."

He says he likes to look at his work over the years and see how he's improved. "My goal is to do better work than we did the year before."

As far as projects go, "My most memorable projects are the ones that gave me the most problems," he says, "because they're the ones that taught me the most."

As for his favorite project, it was one of his earliest ones. The job was for the Holloway Tabernacle in Coffee Springs, Alabama, and it involved a stained and sealed 8-by-5-foot cross made from a

handmade plywood stencil. "I believe in God and he blessed me with talents that have improved over the years," Bayliss says.

He poured and textured the cross to look like wood and airbrushed it to give it shading. He also replicated a stained-glass window that had a beautiful dove and "got real close" to capturing the image in concrete.

He closes with a final bit of sage advice, of which he was guilty of not heeding and had to learn the hard way: "Don't take every job," he says. "Make sure you're comfortable with the job and have the budget to complete the work. If you don't, you'll get into trouble." 

 www.baylissgallery.com



Husqvarna

FLOOR GRINDING SYSTEMS WITH UNBEATABLE PRODUCTION RATES

GRINDERS, DUST EXTRACTORS & DIAMONDS? WE'VE GOT THEM ALL.

Preparing, grinding and polishing concrete floors, as well as repairing and polishing terrazzo and other natural stone are demanding jobs. Our mission is to enable you to perform at your maximum potential by providing you with the right system. Whether that system includes a wireless remote control grinder with Dual Drive Technology™ and an efficient dust extractor or a smaller system with an easily transportable and highly useful small grinder and vacuum. No matter what size of machine you need, they are all equipped to fit our easy Redi Lock® diamond tool system. **800.288.5040**



Museum Blends History with Multiple Processes and New Concrete Products

San Felipe de Austin State Historic Site museum, San Felipe, Texas

by Jeff Bonkiewicz

BEFORE Austin was the capital of Texas and Texas part of the United States, there was San Felipe de Austin, a settlement founded in 1823 by the “Father of Texas,” Stephen F. Austin. Located along the banks of the Brazos River about 45 miles west of Houston, the Anglo colony served as the capital of the provisional government of Texas until 1836 when its residents burned it down during the “Runaway Scrape” retreat from Mexican Gen. Santa Anna’s invading army.

In its heyday, San Felipe de Austin was home to Texas’s first land office, postal service and schools. Although this frontier outpost’s existence was short-lived, its historical impact is long-lasting. For 13 years, the colony was a prominent hub for commerce, government and diplomacy, with ties to nearly every significant character and event of the era.

Project at a Glance

Project: San Felipe de Austin State Historic Site museum

Client: Texas Historical Commission

Architect: Howard+Revis Design, Washington, D.C., www.howardrevis.com

General Contractor: Polished Concrete Consultants, McKinney, Texas, www.polishedconsultants.com

Scope of Project: Historical artwork was adapted for concrete using cutting-edge technology.

Most Challenging Aspect: Working with multiple parties to take the extremely fine detail and translate that into a process that would work on concrete with input and required approval of multiple groups of (out-of-state) architects, contractors and the Texas Historical Commission.

Products Used: L&M Vivid Dye, L&M Lion Hard, L&M PermaGuard SPS and L&M Lumiseal Plus, all manufactured by Laticrete International; Floormap stencils; aluminum oxide; Ameripolish ColorJuice, HTC 950 grinder and HTC tooling to complete the polished concrete interior area.

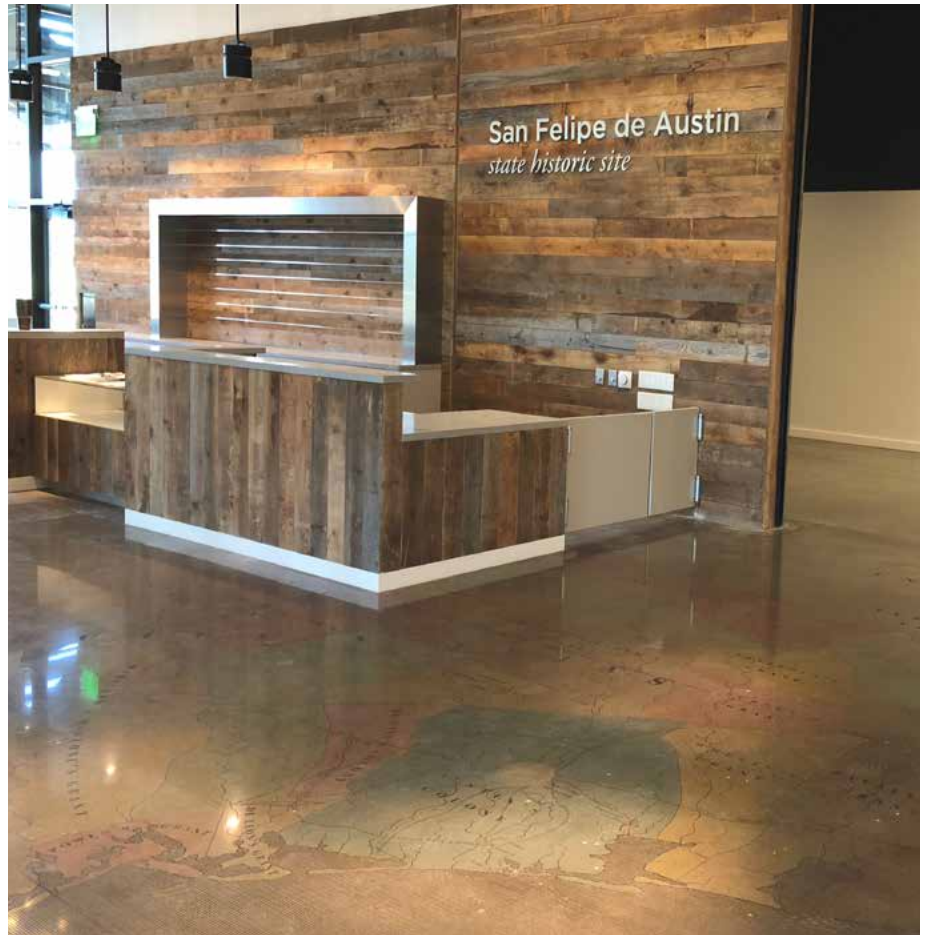

Photo courtesy of Jeff Bonkiewicz

To commemorate this colony that contributed so much to Texas’ history, the Texas Historical Commission had a 10,000 square-foot state-of-the-art museum built at the historic site in San Felipe near Sealy. Here, visitors can experience interactive displays that allow them to be immersed in the settlers’ daily lives.

“We truly believe the museum experience at San Felipe de Austin will reshape the way Texans think about the Mexican-Texas era and the eventual march to independence,” says Bryan McAuley, site manager. The Republic of Texas officially became part of the United States in 1845.

With an impressive array of decorative concrete finishes and new products, the San Felipe de Austin State Historic Site and museum in Texas offer visitors the opportunity to understand the colony’s way of life and its surrounding geography.

The architects, Howard+Revis Design out of Washington, D.C., envisioned serviceable artwork where highly detailed reproductions are captured in the concrete flooring. These horizontally placed masterpieces encompass both interior polished concrete and exterior decorative concrete areas designed to be weathered over time by the elements.



Meticulous maps polished to perfection

Upon entering the main lobby, visitors encounter an extremely detailed map of the Texas territory and the original Mexican land grants. Artists used a combination of techniques to make the polished concrete look and feel like a 200-year-old map that accurately depicts the area's mountains, rivers, creeks, towns, roads and cattle trails.

Using L&M Vivid Dye, a collection of solvent-based concrete dyes manufactured by Laticrete International, artisans altered and customized selected colors to mimic the faded parchment texturing of hand-drawn maps from that era. To accurately portray the map's borders and small creeks down to the smallest detail, they used black dye and acid gel with precut and line stencils. It took seven layers of stenciling, texturing and coloring to achieve the final artistic rendering.

The texturing effects of the acid etching allowed the black dye to penetrate the concrete and magnify the details. The custom color variations were locked into the concrete using L&M Lion Hard, a chemically reactive densifier, and L&M PermaGuard SPS, a penetrating stain protection system applied near the end of the polishing process.

This interior artwork was mechanically polished to provide a shine while lowering the space's maintenance cost and lessening the effects of wear from foot traffic. Overall, the artworks' square footage is quite impressive: While the average 2-D artwork found in museum lobbies across the country measures about 16 square feet, San Felipe de Austin museum's concrete artwork sprawls a good 750 square feet across the main entrance.



Photo courtesy of Jeff Bonkiewicz

Hi-Tech SYSTEMS Polyurea Joint Fillers
Polyurea Pumps
Industrial Crack and Spall Repair Materials

www.hitechpolyurea.com — (800) 454-5530

Durable, high quality repairs with Hi-Tech Repair Materials and local sand/cement



Heavy Duty Pumps and Shavers for Any Size Project

Designed and Manufactured in the USA





Photos courtesy of Jeff Bonkiewicz

Map outdoors protected

Pushing through the north doors leads museum visitors to the outdoor map plaza. This exhibit is a reproduction of Steven Austin's original Colonial submission to the Mexican

government. It accurately portrays the numbered hand-drawn layout of the original colony, including city plot, farm plot and local water sources represented as Austin drew them. The textural variance among all the

independent items is visually stunning. Decorative concrete artisans achieved these effects through multilayered sandblasting, scoring, embossing, etching and pigment coloring techniques. Due to the anticipated negative effects caused by ultra-violet rays and inclement weather, designers ensured that the exhibit's artwork was extremely durable, UV-stable and easy to maintain by museum facility employees.

The only thing that surpasses the visually stunning effects is the functionality of the outdoor exhibit. This 3,000-square-foot work of concrete art will easily handle several hundred thousand visitors per year without any significant issues. The exterior color agents used have an estimated 5 percent color fade over 20 years.

These coloring agents were locked in with L&M Lumiseal Plus, a high-solids, acrylic sealer designed for outdoor decorative concrete. The sealer won't allow stains to penetrate or the color to migrate, both of which would lower the overall aesthetics of the outdoor map plaza over time.



A project of firsts in decorative concrete

This project had several firsts:

- A created-in-real-time acid-etching gel designed to make the line work details more vivid.
- A new, thicker sandblasted map with a modified glue to create a high-strength bond to the existing substrate.
- A high-viscosity, low-bleed, exterior pigment color with a sealer component mixed in.
- A wide variety of indoor and outdoor decorative concrete artwork finishes that haven't been used together before on a single project.

These first-use products and processes were necessary to overcome the project challenges inherent in using foundational concrete as the palette for artistic creation. All the components successfully came together, and the Texas Historical Commission hosted a grand opening in spring 2018.



Special thanks

This project wouldn't have been possible without the vision and the willingness to push the limits of decorative concrete by architects Jeff Howard and Tracy Revis of Howard+Revis and David Stephenson of Polished Concrete Consultants.

The intricate scoring was done by Carlos Acosta from American Concrete Concepts. American Concrete also completed the polished concrete on the interior of the museum.

All the coloring and amazing artwork, both interior and exterior, were completed by Floormap Inc. of

Bentonville, Arkansas, with specific thanks going to Rachel Knigge, Kathren Knigge, Gene Ortiz, Natalie Peyrez, Hannah Roberts and Brandon Schultz.

Stephenson and Joe McReynolds of Polished Concrete Consultants acted as the general contractor for all concrete components. Special thanks to the Texas Historical Commission for its input, directional ideas and financing. 🖋️

YouTube video:

🌐 <https://www.youtube.com/watch?v=ybKP43khADE>

Jeff Bonkiewicz, sales and marketing manager for Laticrete International, is responsible for the company's sales and marketing tools, trade shows, customer trainings, content development, digital promotions and sales management. With decades of experience in sales, marketing and technology, he's well versed in polished concrete, decorative concrete, construction chemicals, surface prep and resinous flooring. Jeff can be reached at jsbonkiewicz@laticrete.com.

Does your commercial space need faster turnaround than epoxy offers?



SPARTACOTE™ offers fast installation and exceeds the demands of heavy traffic environments.

- Fast return to service
- Safe, nonslip textures
- Excellent chemical resistance

www.laticrete.com | 1.800.243.4788

A-8588-1018 ©2018 LATICRETE International, Inc. All trademarks shown are the intellectual properties of their respective owners.



Developing Technology: Installing heated concrete countertops

by Jahn Stopperan

IN the past five years, heated concrete countertops have become more popular and remodelers, contractors and renovators are faced with the task of how best to install them.

Historically, remodelers had to expend a great deal of preplanning, research, design and engineering to meet the requests of clients who wanted heated countertops. This subsequently made the feature expensive and limited to high-end homeowners and business owners.

But thanks to technology, installing temperature-controlled concrete countertops is no longer such a challenge.

Heating countertops history

Originally, contractors placed floor heating coils onto the countertop's substrate, which was typically $\frac{3}{4}$ -inch plywood. They had to predetermine the coils' layout so they could be placed to uniformly warm the concrete. Using a router, contractors created channels in the substrate to accommodate connection wires for the buss system so that the thicker wires could rest below the surface of the plywood and not get compressed by the concrete.

Since the floor heating systems operate using a closed-loop thermal-control method, a temperature sensor was also mounted in the substrate and wired to a controller. Floor heating mats commonly draw a significant amount of power so a dedicated 120-volt



Photo courtesy of Angie's List

Due to the thermal properties of concrete, heat does not radiate laterally within the concrete — it rises vertically through the countertop. The heater shape follows the contour of the countertop's edge, ensuring that the most common place where homeowners rest their forearms is warm.

15/20-amp line from the breaker box was also required. This was especially challenging when renovating an existing home.

Complicating matters was that this process placed the responsibility of the heating solution onto the contractor. If the heating was installed in a way that resulted in the pad overheating or the approach introduced thermal stress points, the contractor often was liable to replace the concrete if it cracked or was damaged in some way.

Preparing and designing this heating solution commonly took four to eight hours.

developed specifically for countertops. This completely changed the level of effort for renovators and installers.

These new heating mats, available from companies such as FeelsWarm and WarmlyYours, greatly reduce the contractor's level of work. Installers just need to provide a sketch or print of the concrete countertop and identify the area of the surface where the heat is desired.

STICKY SIDE UP

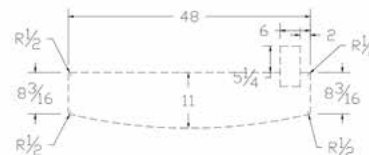

Here's an example of a concrete countertop sketch supplied when ordering a customized heating pad.

Specially designed heating mats

In recent years, the solution has transitioned from floor heating coils to ultra-thin heating mats that were



Heater patterns are customized and follow the countertop so that heat extends to the edges.

Images courtesy of Heated Stone Products unless credited otherwise

Technical breakthrough

The new generation of heating mats mainly provides a breakthrough in four ways:

1. The resistive coil is made with thin highly-ductile foil instead of thick round wire. With a foil thickness of 1.5 thousandths of an inch, the overall heating mat, including the encapsulated high-performance plastic films, is less than 25 thousandths of an inch.



Photo courtesy of Polmaster Construction & Tile Ltd.

Floor heating pads are manufactured in straight runs and have thick connection wires to properly buss the system.

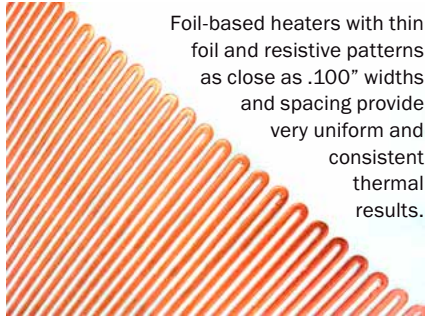

Foil-based heaters with thin foil and resistive patterns as close as .100" widths and spacing provide very uniform and consistent thermal results.

This technology provides a very compliant material that can be compressed by hundreds of pounds. This thinness also enables the pads to be attached directly to the concrete under an overhang without the substrate extending to its edge. The thinness also makes the pad unnoticeable.

2. The mats can be custom produced to any shape or size to match the countertop and cabinet design. They are usually not sized for the entire counter. Rather, they are placed in specific selected areas — typically where people rest their arms.

The heating mats are produced in about a week.

3. The new style of heating pads operates on low voltage (12-24-volt DC), using household power transformers that plug into standard outlets.

For contractors, this means there's no need for a dedicated power line. The heater can plug into an outlet that already exists in the island or countertop area. The maximum current draw for a large mat is 2 amps. Smaller mats draw less current.

4. The heating mats' thermal control differs from floor heating. The heaters, when plugged into the outlet, deliver thermal output to raise the concrete to a peak temperature of skin temperature, about 95 degrees F — which translates into the surface no longer feeling cold.

The thermal rise amount is fixed and is designed into the heater at the factory. This eliminates the need for a sensor in a closed-loop control scheme. Rather, manufacturers provide a simple electronic controller that enables homeowners to decrease the temperature if they want a cooler surface.

Because these new generation



The power supply and controller typically are installed inside the cabinet under the countertop and are plugged into a standard outlet.

heaters are designed for aftermarket homeowner installation, as well as contractor installation, the approach is simple. Contractors just connect two cables and the unit is immediately operational. The cables are designed so that they can't be connected incorrectly.

Roll On Rock[®] • 1 DAY INSTALL
 • 60,000,000 SQ FT SOLD
 • LIFETIME WARRANTY
3-TIMES STRONGER WITH REVOLUTIONARY WICKING TECHNOLOGY



versatile
 building products

866-570-4682
GARAGECOATINGS.COM



BRICKFORM
 A Division of Solomon Colors, Inc.

DECORATIVE CONCRETE OVERLAYS

- Spray Deck Overlays
- Stampable Overlays
- Micro-Toppings
- Colors
- Stains & Dyes
- Sealers
- Stencils & Textures

www.brickform.com

Three basic installation types

Despite a wide variety of custom countertop and cabinet designs, there are generally two basic approaches that concrete countertop heating pad manufacturers consider when designing the pad. There's a third option for concrete counter fabricators who want to integrate the heater into the wet concrete.

1. No overhangs/full substrate:

Contractors will find installing heating mats on concrete countertops with no overhangs, such as islands, to be extremely easy. In these applications, prefabricated concrete countertops rest on a substrate that covers the entire area where the concrete is placed. Heaters will be installed in a minute or two.

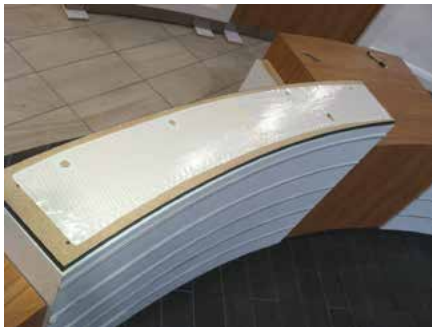

The only prep work for the installer is to drill a 3/4-inch hole through the substrate into the cupboard where the outlet is located. A thin tail from the heater curls down into the hole so a bump or raised area isn't created. The cord from this tail then plugs into the controller or transformer inside the cabinet.

The heater is then simply rolled out onto the substrate and its tail is fed down into the hole.

Next, the concrete can be placed directly on top of the heater. The heater's material construction can handle the weight of the concrete without damage.

2. Overhangs and cabinets

without substrates: For applications with overhangs, heating mats are manufactured with an additional protective layer and a pressure-sensitive adhesive tape on the back.

The heater is mounted onto the underside of the concrete and will remain permanently attached. These heater designs also provide a tight seal to prevent leaking into the body of the heater if something is spilled onto the countertop.

For heater installations with a countertop overhang, there are a few extra steps for the contractor.

The first step is to determine if the heater can be installed after the concrete is placed onto the cabinet or if the heater should be mounted onto the concrete prior to it being placed. Either way works.

A preparatory coating must be applied to the underside of the concrete countertop to enhance bonding. This coating seals the molecular surface and provides excellent adhesion for the heater. This coating is a two-part epoxy that's brushed or rolled on and cures to a hard finish in 30-45 minutes.

The release liner is peeled off and the heater is attached to the concrete overhang about 1/2 inch away from the outer edges. To avoid wrinkles or large bubbles throughout the heater body, this area needs to be wiped. This can take between 30 seconds and five minutes depending upon the heater's size and shape.

If the heater is attached after the concrete is on the cabinet or is an aftermarket installation, the heater may have cut-outs or unique shapes that accommodate corbels, supports or other cabinet features.

After the heater is installed, a 3/4-inch hole is drilled into the cupboard under the overhang. The cord is fed into the hole and a small plug is attached around the wire for a professional look.



3. Embedding the heater into the concrete during the pour:

A third option is to integrate the heating pad within the concrete as the top is being formed. The heating pads are made with materials that can withstand the acids, water content and other chemicals present in wet concrete. Some contractors elect to submerge the heating pad when the concrete is partially poured into the form, then cover the heater with additional wet concrete.



This approach requires a slightly modified heater that has the electrical cord well protected from the rigors of handling and chemistries.





In some instances, the wood substrate directly under the countertop extends to the overhang area. In such applications, the heaters are slightly modified to successfully warm the top surface despite the added insulating wood. Contractors/homeowners supply the details of each countertop installation to the heating pad manufacturer so the company can customize the heating pad to the specific application.

Hookup and controller

The final steps to complete the heater installation for both an overhang and non-overhang application is to connect the electronics. This is a simple process. While the heater may be plugged directly into the low-voltage power supply, most customers prefer a controller so they can adjust the temperature.

Installers mount the controller onto the cupboard's side wall in a preferred location using two screws. The transformer is then mounted alongside the controller using the straps and screws provided.

Finally, the heater is plugged into the controller, the controller into the transformer and the transformer into the outlet.

Final touches

Contractors should be aware that because these new-generation heaters specifically engineered for countertops are low voltage, they don't aggressively accelerate the heating of concrete.

After installation and power-up, the surface may take 60-90 minutes to reach its stabilized temperature of around 95 degrees F. This slow warm-up process ensures that no thermal shock is introduced into the concrete, addressing the risk of cracking.

The heaters are sold in custom-designed configurations as well as in standard rectangular shapes. They are priced primarily on a square-foot basis and start as low as \$250 for smaller standard heaters, including the thermal control unit.

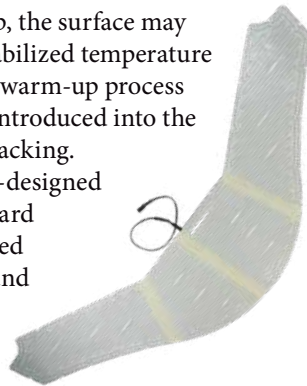

Jahn Stopperan, president of DG Innovations LLC, is a senior marketing and product development consultant for OEMs in the flexible heater and flexible electronics industry. With more than 30 years in design, manufacturing and marketing of low-voltage electronic products, Jahn provides companies with expertise and strategic guidance in consumer, industrial, military, aerospace and medical markets for electronic and thermal solutions. He can be contacted at jstopperan@dginnovationsllc.com.

ARE YOU USING THE RIGHT MIXER FOR YOUR JOB?

- Clays
- Wet & Dry Glazes
- Oil Based Paints
- Latex Paints
- Primers & Sealers
- Waterproofing Materials
- Coatings
- Mortars
- Concrete
- Epoxies

Solving all of your mixing problems for over 60 years!



No Splashing • A TRUE Mixer • Won't Add Air
Heavy Duty • 304 Stainless Steel

Jiffy MIXER CO. INC.



All Jiffy® Mixers are 100% Made in America
Satisfaction Guaranteed
Toll Free (800) 560-2903 ■ www.jiffymixer.com

**INTRODUCING
NEW TRINIC COMPLETE
PRE-BLENDED GFRG MIXES:**

- ECC/ SCC INCLUDING FIBER
- HD ANTI-CRACK FIBER
- EXCEPTIONAL FLEXURAL AND COMPRESSIVE STRENGTHS
- FACECOAT ONE PASS SPRAY-UP
- ENHANCED VERTICAL ADHESION
- REDUCED SHRINKAGE
- BACKCOAT JUST ADD FIBER
- CONSISTENT RESULTS
- TESTED AND PROVEN

JUST ADD WATER.

START MAKING BETTER CONCRETE. CONTACT US:
1 (800) 475-1975 | (607) 775-1948 | www.trinic.us @trinicllc



Reinforcing Ingenuity

Specialty fibers weave their way into more decorative projects

Aldo Buffone, a contractor in New York who has been renovating lofts in the city, credits much of his decorative concrete success to NForce-Pro, a fiber he's been using in his mixes to craft sinks, countertops and shower panels. The mix used for this sink was made with a cement ratio of one part white portland cement, two parts white sand and a generous amount of hemp fiber.

Photo courtesy of Aldo Buffone



Photo courtesy of McMillon Concrete in Las Vegas



NForce-Pro is made from industrial hemp, one of the world's strongest and most durable natural fibers.

Photo courtesy of Canadian Greenfield Technologies

by Rick Yelton

ALDO Buffone thinks of his avocation to be more artist than contractor. Either way, Buffone's efforts are one of an innovator. 1025 Studio, the Philadelphia-based artisan's company, has garnered a local reputation for its creative upgrades of the city's historic downtown loft structures.

The majority of Buffone's unique work is the transformation of drab historic warehouse spaces into modern living areas. The artisan integrates the traditional materials found on-site into the renovation. He's adapted his skills of welding, woodworking and painting into his projects and recently embraced a new material — decorative, fiber-reinforced concrete.

Incorporating fibers in concrete to create durable elements is not new. The Romans first used horse hairs

in many of their iconic structures. And in the last 20 years, fibers have become standard fare to reinforce high-performance floors and slabs.

But what is new is the development of specialty fibers for the decorative concrete industry. These fibers are not the stiff, long fibers that strengthen concrete sidewalks or mitigate plastic shrinkage cracks. These engineered materials provide superior strength at lighter weights for thin panels and countertops.

This new technology of nontraditional reinforcing materials is now aiding Buffone and innovative artisans like him in their quest to create projects that seemingly defy gravity. These products not only help decrease the weight of the concrete element, but they can also enhance the element's service life by increasing the concrete's durability.

Strength with artistry

Decorative concrete contractors are benefiting from the research on ultra-high performance concrete (UHPC). These mixes combine an ultra-high performance mineral matrix with reinforcing fibers. UHPC is commonly used on architectural precast concrete elements such as rainscreens and facades.

UHPC is a useful material due to its special hardening properties. It yields exceptional strength, ductility and durability but, more important for decorative concrete work, UHPC has excellent forming qualities in its plastic state. Artisans can craft significantly thinner pieces that require little or no traditional reinforcement.

Several innovators are transferring UHPC technology into decorative elements. An excellent example is the UHPC-crafted landscape features placed on the campus of Simon Fraser University in Vancouver, British Columbia. Nolan Mayrhofer's Vancouver-based concrete artistry



Photo courtesy of Szolyd Development

A public art project near Simon Fraser University in Vancouver, British Columbia, features Ductal, an ultra-high performance concrete from LafargeHolcim. The mix, reinforced with metallic fibers, is more than six times stronger than conventional concrete, offering compressive strengths up to 30,000 psi.

firm, Szolyd Development, had the leadership role on this project. (<http://www.concretedecor.net/decorativeconcretearticles/vol-17-no-2-february-march-2017/public-work-exemplifies-mingling-of-science-engineering-and-art/>) Szolyd

(pronounced solid) is among the businesses participating in Landscape Furnishings. This is a British Columbia-based group of designers, manufacturers and technologists whose goal is to make durable products that age gracefully and are suited to the environment.



Building for Performance

SAFETY

Storm & Threat Protection
(Steel Reinforced Concrete)



SAVINGS

Downsize HVAC Unit &
Lower Heating & Cooling Bills



COMFORT

Quiet, Exterior Sound
Noise Reduction

VALUE

Net Zero Ready & Long Term Asset
Benefits (Low Maintenance)

1-877-369-2562 | www.foxblocks.com

From flatwork to artistry

Greg Hryniewicz of Hyde Concrete in Pasadena, Maryland, started out as a traditional concrete contractor, but about 15 years ago he expanded into concrete surface treatments including staining, stamping and eventually polishing. Intrigued by the opportunity decorative concrete offered, Hryniewicz and his team became artisans when they cast their first concrete countertop.

Along with professional satisfaction came moderate commercial success. In a short time, Hryniewicz's interest in creating decorative structural elements took off.

In 2016, the contractor launched Hyde Products, a division dedicated to the factory-like production of decorative concrete elements. Hyde Products' portfolio includes unique architectural modern concrete sinks, countertops and other precast products marketed nationwide. He and his team are now expanding into a new production facility poised for growth.

Hryniewicz launched the venture because of his belief that general contractors and building owners are open to a new approach in



Photo by Greg Hryniewicz courtesy of Hyde Concrete

Alkali-resistant fibers are finding renewed interest in decorative concrete, with a new generation of AR-fiber mixes permeating the industry.

construction, such as using decorative concrete elements made offsite.

Attuned to improving profit margins, labor efficiency and project delivery expediency, many general contractors are adopting modular construction techniques and are discovering they are an effective resource.

Hryniewicz believes the No. 1 reason for his firm's successful expansion into modular decorative concrete fabrication has been the use of alkali-resistant glass fibers. First introduced into the European construction industry more than 40 years ago, alkali-resistant fibers are finding renewed interest in decorative concrete, with a new generation of mixes with these fibers permeating the industry. The unique concrete additive not only increases products' durability for transport and installation, but it aids in their final appearance.

Alkali-resistant glass fibers are an engineered material with an affinity to cements. Contractors can use these fibers in their mix design to cast countertops that have high-tensile strength. Since these fibers have about the same density as the ingredients in a typical concrete mix, they quickly disperse with hand-held mixers with minimal clumping.

Many manufacturers use proprietary recipes that blend proportions of micro and macro fibers that ease mixing and maximize concrete's hardening properties. These preblended mixes, many of which are sold in dissolvable bags, include powdered specialty additives that result in a "just add water" batching procedure. Ensured with proper mixtures, users can anticipate concrete products that consistently produce blemish-free textures without the risk of fibers showing.

Micro-fibers to the rescue

Fibers are also improving the durability of concrete repair materials. At World of Concrete 2018, Euclid Chemical introduced a micro-fiber technology that creates a low-shrinkage, highly durable concrete repair mortar.

Decorative contractors attempting minor repairs are often frustrated by the look the replacement material leaves on the total project. If the traditional repair mortar is too rich, portland cement-based materials shrink when they dry and cause cracking. If the repair material is too wet, the bond between the repair and host concrete can be weak.

Euclid's new micro-fiber technology has been specifically developed to help prepackaged concrete repair mortar avoid cracking when hardened. The tiny monofilament, polypropylene micro-fibers are



Euclid Chemical introduced EucoRepair V100, Versaspeed 100 and EucoRepair SCC, repair mortars containing micro-fibers, at World of Concrete 2018.

Photo courtesy of Euclid Chemical

distributed evenly throughout the repair mortar.

The micro-fibers enhance four hardened concrete properties that can reduce repair life. The fibers increase tensile strength, increase the modulus of elasticity, decrease tensile creep and reduce the material's drying shrinkage rate.

 www.euclidchemical.com

Hyde Concrete's success with creating architectural elements using alkali-resistant glass fibers continues. One of its countertops recently was awarded first place in the 2018 ASCC Decorative Concrete Awards program (<https://www.concretedecor.net/decorativeconcretearticles/vol-18-no-2-febmarch-2018/ascc-names-2018-award-winners>).

A lighter alternative

Buffone's key to success is the sense of space with style he creates in nontraditional settings. Since many of his loft renovations have concrete floors, Buffone incorporates that same texture in vertical elements. He's been able to accomplish this look by casting elements that are thin and stylish.

Along with concrete sinks and countertops, Buffone has been creating thin concrete planks that are used as shower wall surfaces and sink backsplashes. These water-resistant decorative surfaces share the same appearance as the main concrete fixtures.

Buffone credits much of his decorative concrete success to NForce-Pro, a fiber he's been using in his mixes. Introduced during World of Concrete 2017, NForce-Pro is manufactured from industrial hemp, one of the world's strongest and most durable natural fibers.

NForce-Pro is specifically designed for decorative concrete by its manufacturer, Canadian Greenfield Technologies Corp. It provides the same strength

characteristics as glass fibers but at about half the weight.

The hemp fiber is the result of CGT founder Mike Pildysh's keen interest in offering an effective concrete ingredient. Pildysh, who has been active in the concrete construction industry for more than 35 years, used his experience in structural design and concrete admixtures to come up with the concept of using natural fibers. Since the fibers are hydrophilic, their physical characteristics cause them to better disperse in fresh concrete during mixing and placing.

However, CGT faced a challenge when it came to commercially manufacturing the fibers. The company had to figure out a way to devise an effective processing method to properly create the size and nature of a suitable fiber.

Development went forward when CGT came up with a special processing machine that first focused on producing fiber segments suitable for concrete that didn't damage the fiber's structure. CGT's research and development team engineered NForce-Pro to provide maximum mix stability and exceptional surface quality in decorative concrete applications.

There is an additional benefit to this natural fiber — it's a sustainable



Photo courtesy of Aldo Buffone

Thin and stylish vertical panels, such as these shower walls reinforced with hemp fiber, are part of the ongoing loft renovations in New York City. Many of the lofts have concrete floors and the panels add a complementary, as well as a sustainable, touch.

product with a low carbon dioxide footprint. Buffone uses NForce-Pro to enhance concrete's plastic and hardened properties, but many of his clients are simply intrigued that their decorative concrete was made with a sustainable material.

"They welcome being able to tout how green the concrete is by using hemp," says Buffone.

- www.canadiangreenfield.com
- www.hydeconcrete.com
- www.landscapefurnishings.com
- www.szolyd.com

PROTECT IT

CONCRETE PROTECTION PROCESS

STAIN IT

23 NON-REACTIVE STAINS

SEAL IT

MARKET LEADING SEALERS



WWW.REDIMIXCOLORS.COM
508.823.0771

SHIPPING WORLDWIDE!
FREE SHIPPING ON
STAINS & SEALER PRODUCTS

Proper Testing Can Pinpoint Moisture Problems

by K. Schipper

WHEN you're relaxing with a woodworking project in your garage, an important adage is "Measure twice, cut once."

When you're called in to decorate a concrete floor, measuring twice isn't necessary, but do measure the moisture in that slab before proceeding.

Sure, you can eyeball it, but a wrong guess on how much moisture is in the concrete may mean even the best product can flake, chip or delaminate — leaving you with an unsightly mess and an unhappy client.

Got moisture?

Walking up to a job site, just about any experienced contractor is going to have an inkling of at least the potential for moisture issues. It is visually possible to tell when a problem is present.

Larry Bucher, national manager of architectural products/terrazzo for Key Resin Co. based in Batavia, Ohio, says an experienced contractor will notice shades or shadowing in the concrete, and look at how and where the job sits.

"Most slabs will exhibit obvious moisture issues or tendencies," he says. "A seasoned contractor will look at the color of the concrete, check for dark marks in it and look at the site."

"Yeah, I can probably tell 90 percent of the time after years of just looking at it," says Carl Schlosser of AAF Flooring in Stony Brook, New York. "You can see how dense it is or how soft. And, if it's above grade, typically you have a good chance of no moisture, but that isn't necessarily true if it's on grade or below."

However, Rob Schumacher of Phoenix Commercial Flooring in Hicksville, New York, says there are other things he looks for, as well.

"A vapor barrier is important, but other factors include whether it's close to the water, say an area with a high water table, or improper drainage around the building," Schumacher says. "Sometimes the drainage will be toward the building rather than away from it."

That's not to say a project that's above grade is going to be safe from moisture issues, though. Both Schumacher and Schlosser cite the use of concrete that may not be quite up to the job.

"The masons who are doing the concrete might not have used the right mix," says Schlosser. "It might have too much water in it to begin with or not enough sand. Often, the problem is because the mason contractor has

dropped the ball."

For that reason alone, it's not possible to limit problems with moisture to certain geographical areas of the country. Jeff Bonkiewicz, channel manager with Laticrete North America based in Bethany, Connecticut, says while that company sees high demand for its moisture mitigation products from the South and Southeast, there's also a lot of call for its products from the Midwest and Southern California.

"In really arid areas, such as Phoenix, you usually have less moisture issues," Bonkiewicz says. "That's due to its arid geography and topography, but that doesn't mean you don't have any."



It's hard to beat the look of a freshly coated floor. However, unless you're certain of the amount of moisture in the floor — and if it's high you've done the proper prep before installing a moisture barrier — today's beautiful floor can be tomorrow's mess, complete with unhappy customer.

Photo courtesy of Laticrete

To test or not to test

In a perfect world, there is one situation where migrating moisture isn't a problem. That's if the concrete has been mixed correctly and there's a proper vapor barrier under the slab.

Glenn Tench, director of marketing for Hampshire, Illinois-based W.R. Meadows Inc. — a company that manufactures vapor barriers — says if you know one is present you can breathe a little easier.

“With a properly installed vapor barrier, one that meets ASTM (International) E1745, you aren't going to have the issues with moisture migration post-construction,” he says. The only things you'd be dealing with is the concrete's age and if enough moisture has migrated out so you can install the flooring.

The other exception: if the job is outdoors. Bonkiewicz estimates 99 percent of Laticrete's moisture mitigation products are used indoors, and Key Resin's Bucher says most exterior jobs use “breathable” toppings that allow the moisture to go through.

If you can't give a positive answer



Photo courtesy of Wagner Meters

Just how much moisture is in that concrete slab? You can guess or — with the help of some properly placed electrodes — you can rely on the latest technology to give you a definite number.

to the vapor barrier — and, with older concrete, you may not be able to find out the answer — your only other option is to test to see if moisture is present.

Testing is an approach recommended by both product manufacturers and contractors alike.

“We always recommend a moisture

test first,” says Bonkiewicz.

“We recommend testing 100 percent,” says Bucher. “It's a bad risk not to test all slabs prior to applying any floor covering or finish.”

“We always test, absolutely,” says Schumacher. “It's much more reliable than going by visual appearance.”

CRITICAL DECISIONS NEED CREDIBLE READINGS



Ambient relative humidity readings
RH, temperature, dew point & grains/pound readings
Instant, non-destructive concrete moisture monitoring

sales@tramexmeters.com
www.tramexmeters.com



“It only takes a couple of minutes to drop a can in it and read it,” says Schlosser. “It’s not a big deal to test it.”

Schlosser’s “couple of minutes” is a bit more complicated than that, of course. However, the preferred method for testing the moisture in a concrete slab isn’t all that complex and has recently become less time-intensive, as well.

“I like the Rapid RH system,” he says. “You just drill a hole in the concrete, the sensor goes in and you have an electronic meter that goes into the sensor that will give you temperature and

relative humidity pretty well instantly.”

That product’s manufacturer, Wagner Meters of Rogue River, Oregon, requires the sensors be left in the concrete for 24 hours — down from 72 hours — in a frequency established by ASTM.

And, product manufacturers don’t necessarily favor the RH (relative humidity) test over its main competitor, which measures the weight of calcium chloride packets left sitting on the concrete for 72 hours.

“We don’t have an official testing procedure we recommend,” says

Laticrete’s Bonkiewicz. “We leave that up to the concrete and coatings pros who work in the field every day.”

A big question must be how the property owner, building manager, general contractor or whomever is overseeing the job feels about taking the time to test. Schumacher says it hasn’t been a problem in his experience.

“They understand,” he says. “They want the job done right, they want it to last and they’re paying good money for the installation, so they certainly understand.”

Testing concrete slabs for moisture

Technology continues to do its part to turn working with concrete from an art into a science. Take the matter of moisture in concrete slabs.

A few years ago, determining whether moisture was present in a slab was mainly a matter of eyeballing the project and then rolling the dice on the best solution to an apparent problem.

Now, not only can technology help pin an exact number on the amount of moisture present, but it can provide — and remember — additional data, as well.

The earliest efforts to measure the amount of moisture present relied on weighing packets of calcium chloride that had been strategically placed around the job site per an ASTM requirement and allowed to sit for 72 hours.

Today, most contractors favor using electrodes drilled into the concrete — again in the same frequency required by ASTM — that can measure not only relative humidity but also temperature and, depending on the manufacturer, other climate conditions. Bluetooth technology is then used to read the information, record it and send the data to the contractor in a choice of formats.

Two of the leading purveyors of testing equipment for the industry are Wagner Meters in Rogue River, Oregon, and Tramex Moisture Meters of Kilmacanogue, Ireland. Both companies use electrodes drilled into the concrete, then read for their information.

“You drill into the slab to 40 percent of whatever the overall thickness is,”

says Jason Spangler, Wagner’s product manager. “Once you do that, you vacuum it out, put the sensor in there, cap it and leave it for 24 hours to get your reading.”

Accepting a measurement after 24 hours is relatively new to the process, he adds, and was approved earlier in 2018 by ASTM after a precision-and-bias study showed that a 24-hour reading was essentially identical with a reading after 72 hours.

While the biggest advantage of these systems is to identify slabs where moisture can be a problem for a topping application — including tile and carpet — it’s providing additional info while the job is being worked.

For instance, says Ronan Carrigy, marketing manager for Tramex, additional information can show temperature, humidity ratio and dewpoint at the job site.

“That can be very useful at the time of the application of the coatings,” he says. “They help identify moisture that may be present due to condensation on the surface.”

Additionally, he says, instant nondestructive tests provide moisture content readings that indicate when and where to carry out the in-situ test or if there is condensation at the time of application of coatings, and log data continuously.

Surprisingly, Spangler says, there’s still some resistance to testing slabs for moisture, particularly among those who have decades of experience in the



Photo courtesy of Tramex

A good metering system will not only measure the moisture in the concrete, but show (and store) additional data such as temperature and humidity while the job is being completed.

industry. However, it’s better than using a crystal ball to read the future of a project.

“It allows them to see what’s going to happen once they put all the time and effort into putting a floor down,” he says. “It can tell them what will happen after they install. You get a better sense of security by doing this type of testing.”

“It’s always possible to visually identify moisture-related problems once they’ve occurred,” echoes Carrigy. “They manifest themselves in very obvious and displeasing ways such as staining, bubbling, blistering and spalling — once it’s too late.”

— K. Schipper

www.tramexmeters.com

www.wagnermeters.com

Doing it right

If the moisture level is greater than 80 percent, it's time to go with a moisture-mitigation product. Finding the right product is as simple as finding one that meets or exceeds the ASTM F3010 standard, which will then essentially become a vapor barrier on top of the concrete, says Meadows' Tench.

"It will act as a priming agent for concrete between your epoxy or polyaspartic coating that you're going to put on top of the primer," says Laticrete's Bonkiewicz. "That will provide an extra insurance policy against delamination and moisture."

Depending on the product, it may also accept pigments and even allow the broadcasting of chip or quartz media. And when installed properly, it likely comes with a warranty.

The availability of that warranty boosts a client's confidence, but it also requires installers to pay close attention to the product's installation. As Bonkiewicz notes, bad prep will void the warranty.

"For the record, that's our No. 1 issue in the field," he says. "We stress to our customers, never skimp on the surface prep. Take it seriously because the entire job is riding on it."

Because Laticrete recommends a concrete surface profile of anywhere from three to five for its moisture mitigation product, shot-blasting is the suggested method for surface prep.

Never skimp on the surface prep.

The contractors agree, although Schlosser says he will sometimes profile with a grinding machine.

"Prep is often a step people overlook," he says. "They cut corners, or they don't profile, and that's where it goes bad. Get your test readings and do the prep."

Key Resin's Bucher even recommends doing another moisture test once the floor is opened up.

"Once you blast a floor, you're going

to start drying it up," he says. "If you test an unblasted floor, it will read differently. Ideally, you should blast the floor and then do the readings, but people don't want to take the time."

Once your surface is prepped, good application is also key. It's critical to get enough product down, says Bucher.

"Pay attention to the mixing instructions on the data sheets and don't cut corners on surface prep," says Bonkiewicz.

Bucher compares doing the moisture testing to carrying car insurance, and Schlosser says he's turned down jobs where the people contracting the job weren't willing to take the time to have it done.

"What if the client has moved in all their furniture and desks and glass walls and there's a problem," he postulates. "Are you going to try to fix a concrete slab with everybody on it?"

- www.keyresin.com
- www.laticrete.com
- www.pnxfloors.com
- www.wrmeadows.com

GranQuartz® Introduces EZ POLISH SYSTEM



**Simple Process,
Perfect Finish
Every Time!**

**3 Tools
3 Chemicals
1 RA Meter**

This system allows the project to be delivered with less installation time, lower costs and measurable results.

GranQuartz +  =
**Changing the way
you polish concrete!**

THE PARTNER THAT
HELPS YOU **SHINE!**

PROVEN QUALITY PRODUCTS | EDUCATIONAL SEMINARS | KNOWLEDGEABLE REPS

csc.granquartz.com • 866-639-0960



Better Safe Than Sorry

Proper PPE is a must on today's job site

Anyone who works with concrete knows it can do a slow burn on exposed skin. That's why this well-protected worker has gloves, boots, a long-sleeved shirt and eye protection. The reflective gear and hardhat protect against unseen dangers.

Photo courtesy of MCR Safety



Photo courtesy of MCR Safety

by K. Schipper

IN recent months, most of the safety emphasis in the industry has been on crystalline silica and new regulations designed to keep it out of concrete workers' lungs.

Both equipment manufacturers and contractors have worked hard to come up with new products and processes to keep their workers safe.

Unfortunately, dust generated by polishing and grinding is hardly the only danger concrete employees face on the job. Eyes and ears, hands and feet, heads and more are all at risk on the job site, and that will likely continue as long as people head off to work each morning.

However, just as with silica dust, there are ways to mitigate the problem. There are plenty of experts out there, available to companies large and small, who can help ensure people leave work in much the same condition as they arrived.

PPE provisions

Pres. Ronald Reagan generated plenty of laughs over the years with his contention that some of the most-frightening words ever spoken were, "We're from the government and we're here to help you."

However, for many people their first line of defense with job site safety is the federal Occupational Safety and Health Administration (OSHA) or — in states that have chosen to write their own, stricter standards — a similar state agency.

In an industry that sees as many as 28,000 injuries a year, according to Chris Smith, director of marketing and inside sales for MCR Safety based in Collierville, Tennessee, personalized protective equipment (PPE) doesn't just include lung protection. For concrete workers, it also largely includes eye and skin protection.



There's a glove for almost every job. For some, hand protection means guarding against trauma.

Photo courtesy of Bullard



Other gloves are designed to protect against chemical exposure. Product manufacturers will often specify the type of glove for a given application.

Photo courtesy of H.D. Supply Construction & Industrial/White Cap

Finding out exactly what's required isn't always an easy matter. A simple search of "concrete" in the OSHA website turns up more than 200 different entries.

However, when it comes to PPE, the agency is quite clear. For construction, Section 29 CFR 1926 Subpart E notes OSHA standards require that not only will PPE be provided, used and maintained in a sanitary and reliable condition, but it must be provided by the employer. And, employees must be able to clean or exchange PPE if it becomes ineffective or contaminated while in use.

And all this must be done "at no cost to the employees with limited exceptions."

For employees whose companies are working on large job sites, there are a couple of other advantages as well. Michael Katz, category director for safety at H.D. Supply Construction & Industrial/White Cap in Norcross, Georgia, notes that large contractors are going to have a safety officer on-site and regular safety training is the order of the day.

His co-worker, Erica Meloney, the senior safety manager, adds, "If you're walking onto a large job site, there will possibly even be a picture of a worker showing everything the worker is required to wear, and descriptions in both English and Spanish."

"Almost any worker has some set of PPE that's mandated," says Katz. "It can include a hardhat, glasses, gloves and a high-visibility vest. The type of job that's being done would mandate whether that includes a respirator or not."

The right stuff

If you're a sole proprietor or own or work for a small company, Katz's list is probably a good place to start, but it's certainly not complete.

One item that isn't always easy to see and is sometimes forgotten in the mix is hearing protection, according to both John Paesano, category director for concrete, restoration and waterproofing at H.D. Supply, and Stacey Simmons, product manager for Bullard in Cynthiana, Kentucky.

Simmons explains that workers must be protected if they're continuously exposed to noise greater than 85 decibels (85 dBA), or the sound of city street traffic. The reason: once hearing is damaged, that loss is not reversible.

"It's certainly recommended when you're preparing a concrete substrate, whether it's a parking garage or a sidewalk," says Paesano. "Whether you're using a grinder or a shot-blast machine, those are noisy and while we sometimes take that for granted, ear protection is definitely needed."

How does the average person know they're getting the best product for a specific need — even if they're shopping at a big box store? Not surprisingly, OSHA outlines standards for approved products for use on the job site.

Simmons, who chairs the ANSI/ISEA (American National Standards Institute/Industrial Safety Equipment Association) committee on head protection, explains that the federal agency adopts the standards, which are updated every five years or so.



Extreme job sites require extreme protection, such as this combo, which includes a disposable protective coverall as well as eye and respiratory protection.

Photo courtesy of MCR Safety

"We're competitors sitting around the table," she says. "But, at the end of the day, we want workers to go home in better condition than when they arrived at work that day."

In Canada, similar regulations are set by CSA Group, formerly the Canadian Standards Association.

And, Simmons doesn't discount doing a little research at the nearest big box store.

"Big box retailers, including Home Depot and Lowe's, have full safety bays, with safety vests, respiratory masks, hardhats and gloves. These retailers won't direct you specifically on what to buy, but they do cater more to professional do-it-yourselfers."

Other sources of information can



Nobody likes wearing a respirator, but for some jobs there's just no getting around it. Not only are these workers protecting their lungs, but they're guarding against skin exposure with boots, gloves and covering clothing.

Photo courtesy of H.D. Supply Construction & Industrial/White Cap

be the technical data sheets and material safety data sheets that come with the products contractors are using, whether they're stains, release agents, color hardeners or whatnot.

"The manufacturers provide that information but sometimes you have to ask for it," says Dan Anna, Ph.D., CIH, CSP, the senior industrial hygienist at Johns Hopkins University Applied Physics Laboratory in Laurel, Maryland, and past president of the American Industrial Hygiene Association. "The safety data sheets will give you general information, but not always enough specific guidance, unfortunately."

For those that do, however, the information may be specific enough to advise users to use chemical-resistant safety glasses, an organic respirator or a dust mask that's approved by two other federal agencies, NIOSH (the National Institute of Occupational Safety and Health Administration) and MSHA (Mine Safety and Health Administration).

Saving someone's skin

While respiration protection for anyone working around dry concrete or powdered chemicals is a must, along with lung protection, the biggest concerns for concrete workers

Technology Will Improve Job Site Safety

As enforcement of the most-recent rules for silica dust exposure loomed on the horizon last year, many people were concerned they'd all be working in respirators or hoods.

Instead, incorporating more wet methods into some jobs and adding better vacuum systems to equipment went a long way toward resolving dust concerns. It's the approach that Dr. Dan Anna, past president of the American Industrial Hygiene Association, says his profession prefers.

"The focus of the industrial hygienist is to do what we can to avoid having to use PPE," he says. "There have been a lot of technological advances that seem really simple, but the tools and equipment are there for us to look at opportunities to eliminate potential hazards."

Probably nowhere is technology more likely to soon have an impact than around heat safety. There's nothing like a hot, humid summer day to increase the danger of heat stroke, so wearable monitoring devices for checking heartbeat and other health indicators may soon be incorporated into common items such as eyeglasses, hardhats and even shoes.

Dennis Capizzi of MSA Safety says that while the technological curve in the safety industry is pretty much like a hockey stick, he expects items connected by Bluetooth or long-range radios will be regularly hitting the safety market.

Stacey Simmons of Bullard agrees. She believes the workplace of the future will be much more connected — to the advantage of people out in the field.

"Imagine having biometrics where you can send a signal that you have a man down or a worker is over-heated, or their heart rate is elevated, possibly signalling a heart attack," she says. "Technology is going to play a big part in the PPE area down the road."

However, Anna sees it going beyond that. In the future, he expects wearable sensors to continue to be built into products, giving users a much better idea of when to dispose of the gloves that are no longer providing adequate protection or indicating time to change out a respirator cartridge.

It can even go beyond that, he says, making the job site of tomorrow much different than it is today.

"We'll have a better look at the big



Tomorrow's PPE will do more than just passively protect. Built-in sensors will monitor such metrics as whether a site is too hot — or too cold — and even how the wearer is feeling, then advise when a replacement product is needed.

Photo courtesy of Trimaco

picture of what the impact of cutting concrete eight hours a day does to a person physiologically," he says. "We'll have more data and information, and that will get us thinking about what we have to do to the tools and equipment they're using.

"This new ability to capture information should bring a fascinating evolution over the next few years."

— K. Schipper

are eye and skin protection.

When it comes to eye protection, the ANSI/ISEA standard for impact protection is Z87.1-2010. Glasses are supposed to protect eyes from flying particles, molten metal, liquid chemicals, acids or caustic liquids, chemical gases or vapors or potentially injurious light radiation.

Where eye protection isn't enough, a face shield may be required. Even for employees who aren't working directly with the concrete, its caustic nature requires that eye protection is needed anytime concrete dust is present, with goggles recommended, according to MCR Safety's Smith.

But dust isn't the only issue. Because wet concrete is highly alkaline and can burn in a matter of hours, long sleeves and pants are a must, as well as waterproof boots and gloves that are waterproof and alkali-resistant.

Anna says gloves can be a complicated issue, which helps explain the extensive selection of work gloves carried by some suppliers. While a typical work glove is mainly designed to protect from trauma, concrete workers need more.

"When you start getting into using chemicals and your hands are going to be in a powder or a liquid, then you have to look at that chemical and which gloves are appropriate to protect from exposure," he says. "If you have the wrong glove material, it can permeate right through, almost like you have no glove on at all."

Fortunately, Anna says, many manufacturers offer guidance tables on what work glove material should be used to protect against a given chemical, and if or how long it will take for the chemical to break through the glove material.

Fit for success

Along with the manufacturers' websites and blogs, other sources of information on these products include the websites of OSHA, ANSI and NIOSH. And, even after a person has found the best product for his or her specific needs, there are a couple of other things to keep in mind.

One is that while some products — think safety vests — are a one-size-fits-all proposition, others are not, and fit can be critical to their successful use, says Dennis Capizzi, the industrial customer marketing manager for North America for head, eye, face and hearing for MSA Safety based in Cranberry Township, Pennsylvania.

"Properly fitting equipment helps to ensure that the equipment will perform as designed," he says. For example, a respirator that hasn't been fit tested prior to using on a job may have gaps on the sealing surface where the mask touches the face. These gaps may allow contaminants to enter.

"Size selection, fit testing and proper donning per the manufacturer's instructions will help the user determine which mask size and style fit properly to ensure a secure fit and optimal protection," Capizzi says.

These items also don't last forever. Many products come with information on when they should be replaced, but a daily visual inspection is critical.

"The hardhat shell MSA produces can last up to five years, and the suspension can last up to one," Capizzi says. Other factors, such as environmental conditions and use, can influence PPE's life expectancy.



MSA Safety provided helmets for artisans and attendees at Decorative Concrete LIVE! in Las Vegas earlier this year. The need for such a "lid" on many job sites can't be stressed enough. It should be fitted to the wearer and replaced regularly.

Photo by Concrete Decor Staff

Users should follow the manufacturer's instructions and inspect PPE before and after each use for signs of wear or damage. If any is found, "That item should be taken out of service, repaired or replaced per the manufacturer's instructions," Capizzi says. 🛠️

- 🌐 www.aisa.org
- 🌐 www.bullard.com
- 🌐 www.hdsupply.com
- 🌐 www.mcrcsafety.com
- 🌐 www.msasafety.com

Spin Screed[®] Inc.
DEVELOPER OF THE WORLD'S LIGHTEST WEIGHT POWER ROLLER SCREED

Now Available!
Screed Support System

NEW from Spin Screed, the Screed Support System reduces fill volume by 85% compared to a pipe screed.

Complete
Rugged
22' Wide Screed
\$1,599*
+shipping
*prices subject to change

Please visit our website
spinscreed.com
to see videos & our complete product line.

888-329-6039
5032 College Avenue-Suite B • Quincy, IL 62305

Compression vs. Adhesion:

What's more important when testing decorative overlays?

by Chris Sullivan

WHAT is the most important test when it comes to evaluating decorative concrete overlays? A case can be made that any test result can help better define how a product will perform, but when it comes to decorative overlays some tests are more meaningful than others. The test I find most important when looking at overlays, but one which is often overlooked, is tensile bond strength.

I was fortunate enough to be part of a group that recently completed a multiyear study that compared properties of various polymer-modified cement-based overlays. We looked at the impact of mix design, aggregate type and size, polymers and water-to-cement ratio on the final properties of various products. In many cases the results turned out as expected, but there were some surprises.

As the group compared notes and discussed the end results, it was no surprise that compression testing — material strength under load — was the result everyone automatically asked about. It also became evident that the second most important property the group was interested in, many times without even realizing, was adhesion — how well the overlay was bonded to the substrate.

So this got me thinking, which test is more important when looking at decorative overlays — compression or adhesion?

Compression strength

Before we can answer that question, we need to understand the basics of compression and adhesion testing in regard to concrete and overlays. Since ASTM International (www.astm.org) is the accepted leader for testing, we'll stick with its test methods.

Compression testing is used to establish the crush resistance of a material — how much force can be applied straight down before the



This sample disc from ASTM C1583 Bond Strength Test shows a clear B-type break within the overlay.

Photo by Chris Sullivan

material fails. Decorative overlays fall under ASTM C109 – Standard Test Method for Compressive Strength of Hydraulic Cement Mortars (<https://www.astm.org/Standards/C109.htm>).

A 2-inch cube of overlay is produced in a mold, removed, allowed to cure and then subjected to a pressure force until failure. The test is run multiple times, with the average being the accepted strength, usually measured in pounds per square inch (psi). In many cases, decorative overlays are compared to concrete when it comes to compression, with a target accepted range of 3,000-4,000 psi set as a benchmark.

Adhesion

When we look at adhesion of overlays, ASTM C1583 Standard Test Method for Tensile Strength of Concrete Surfaces and the Bond Strength or Tensile Strength of Concrete Repair and Overlay Materials by Direct Tension (Pull-off Method) is the accepted test (<https://www.astm.org/Standards/C1583.htm>).

The test, performed by applying it

cure, determines the bond strength of the overlay to the substrate. A series of circular cuts are made through the overlay into the substrate to a designated depth. A metal disc is epoxied to the surface of the overlay and a special hydraulic press is used to pull the disc until failure. The results are measured in psi or mega Pascals (mPA).

As important, but often overlooked, are the location and type of failure. The types of failure range as follows (see diagram below):

- (A) Epoxy to overlay contact point.
- (B) Within the overlay.
- (C) Overlay to substrate contact point.
- (D) Within the substrate.

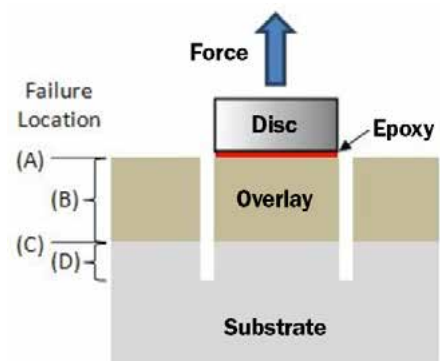

Diagram courtesy of Carrasquillo Associates

There are also combinations of these failures measured in percentages of each type. The best result would be if the epoxy failed before the overlay or substrate, but we don't often see that in practice. The least desired result is to have the overlay fail at the contact point with the substrate, which would indicate poor material adhesion.

It's interesting to note that decorative concrete overlays exhibit weak adhesion (typically below 500 psi) when compared to other industrial coatings and toppings, such as automotive paint and industrial primers.

Compression vs. adhesion

So back to our question — why is there such a focus on compression and not adhesion? I'm pretty sure the "concrete umbrella" effect is in play. Compression strength is the No. 1 property when dealing with concrete. Compression equals strength, which is what most people associate with long-

term performance and durability. Since decorative overlays contain cement and the word "concrete" they tend to get lumped under the "concrete umbrella."

In my opinion what is lost with the heavy focus on compression strength is that an overlay can be strong, but if it doesn't "stick" strength doesn't matter. The study showed that in many cases as compression strength increased, adhesion decreased. The focus for producers when developing overlays is the point at which strength and adhesion properties are optimized. This is not always going to be the material that promotes itself as the strongest.

When you consider the leading cause of failure with overlays is delamination, having a material with high adhesion strength can go a long way to offsetting that problem. I'd also like to note that high adhesion strength is not a replacement for proper surface preparation, which remains the most critical part of any overlay application.

Decorative overlays are hybrid materials that come in many formulations. Differences in polymers and mix design have a huge impact on the performance. A product that does well in Florida may not do well in Minnesota. There are also materials that are better suited for interior use. I encourage anyone who deals with overlays and coatings to do some research to better understand the common tests and which properties are most important for your application. 🛠️

Chris Sullivan is vice president of sales and marketing with ChemSystems Inc. and a member of the Decorative Concrete Hall of Fame. He has led seminars and product demonstrations throughout North America. Reach him at questions@concretedecor.net.

BUTTERFIELD[®]
COLOR

A reactive penetrating sealer that can be applied to 2 day old concrete

Clear Guard[®] First Seal[®]



- Water-based, low VOC, low odor
- Non film forming
- Helps to protect concrete from erosion caused by de-icing chemicals
- Promotes adhesion of topical sealers



Is your concrete ready for winter?



800.282.3388 | www.butterfieldcolor.com



THE
BUILDINGS
SHOW



WORLD OF
CONCRETE®
TORONTO PAVILION

**Transform.
Build.
Innovate.**

REGISTER TODAY!

NOV 28 - 30, 2018

Metro Toronto Convention Centre

thebuildingsshow.com

Supported By



CONCRETE
ONTARIO

CONCRETE POLISHING HQ

1-888-799-CPHQ (2747)

For more information
email us at orders@cphq.net

Our SERVICE and SUPPORT Go UNMATCHED

**Sales • Support
Rentals • Training
Same Day Shipping**

www.ConcretePolishingHQ.com



BDC SUPPLY

for all your decorative concrete supplies, tools, equipment, rentals & training.

*We ship anywhere in the U.S. and offer free Chicagoland deliveries.**

*Restrictions apply.

120V Blaster Only \$3,600

NEW LOCATION!
258 Theodore St., Crest Hill, IL • www.bdcsupply.com • 800.781.6799





Sparkle Grain

"adds a sea of diamonds to your concrete"

The Sparkle Grain Finish is a broadcast application that produces an eye-catching sparkling concrete surface. Sparkle Grain can be applied to integral or dust-on color for exterior and interior uses. It makes an excellent longwearing, non-slip surface.

Pacific Palette Concrete Products
P.O. Box 5176 Santa Cruz, CA 95063
831.457.4566 www.sparklegrain.com



Fossil Stamps

Pacific Concrete Images

www.pacificconcreteimages.com 949-581-0270



subscribe

go to ConcreteDecor.net

concrete DECOR

Bright Idea
Artist Joshua White Incorporates High-Contrast and Concrete



BLUE BEAR

600GL Coatings Remover

Powerful and safe, **600GL** removes multiple layers of paints, urethane & epoxies in one application. **600GL** is biodegradable & safe for you and your customer.

franmar.com Dealers wanted: 1-800-538-5069



«« REGISTER FOR THIS FREE WEBINAR TODAY! »»

MOISTURE TESTING

OF CONCRETE FLOOR SLABS

WAGNERMETERS.COM/WEBINAR • 800.207.2164

Industrial-Grade Pressure Washers

WaterCannon.com 35

WaterCannon.com 800.333.9274



Out of the Blue

by Stacey Enesey Klemenc

WHEN Christina Arnall signed up for Ben Ashby's advanced countertop class in Las Vegas about four years ago, she had no idea it would lead to an epiphany. It began when Ashby introduced the group to his ½-inch admix being used to create a shower panel and they decided to color it blue.

"In that moment, my head exploded, and I got the idea that if you could make concrete blue and that thin then I could make it look like anything," says the co-owner of D.C. Custom Construction Inc. in Quincy, Washington. Arnall told the instructor she could recreate Vincent van Gogh's *Starry Night* with the mixture. Ashby scoffed at the concept, she remembers, which made her determined to succeed.

Nearly four years later, she's pretty much perfected a technique that allows her to "paint" with a modified version of Ashby 1/4-1/2-inch Admix, custom color blends from Solomon Colors and Direct Colors and paint pigments from Sherwin-Williams. Besides *Starry Night*, she's replicated other masterpieces, including Wassily Kandinsky's abstract titled "Panel #1" which, she says, "just set me on fire." Her largest piece to date — a three-piece, 21-foot-by-44-inch mural — graces the Mission Ridge Ski Resort in Wenatchee, Washington.

Arnall begins with a melamine mold sealed with silicone, "the same as you would use for a countertop," she says.



She outlines her artwork with black silicone caulk and strategically places colored concrete in predetermined places, noting the design needs to be "flipped and poured backwards from front to back."

She then adds enough admix to fill the mold and vibrates the entire thing. After many tests and trials, she's landed on a technique that gets the layers to stick together while keeping the colors separate and intact. She's also figured out how to create and control voids to use for her benefit.

After 30 hours, Arnall demolds the piece and lets it dry for another 12. Next, she seals the concrete to bring out the colors and prepares it for grouting. Six hours later, the grouting begins with anywhere from two to 15 colors — a process that really makes the design pop and the details dance. The finishing touch involves applying a penetrating sealer, followed by several coats of countertop-grade sealers to lock in the color and texture.

The whole process takes seven to 10 days.

Arnall — who has spent the last

20-30 years as a painter, tiler and general contractor in addition to a concrete artisan who has done everything from carving and countertops to overlays and floors — credits her artistic success to her wide range of experience and ability to put together all that she's learned from the various trades. These days the self-labeled "concrete junkie" devotes most of her time to her framed concrete "paintings" and custom shower panels that she ships all over the country.

"It's a totally different way to look at concrete," Arnall says, adding she gets calls from artists who want to know her method. "I guess I cracked the code." 🛠️

🌐 www.dccustomconstruction.net



MAPEI: Your single-source provider from restoration to protection

Decorative Concrete Flooring system solution



In addition to decorative concrete solutions, MAPEI offers a full spectrum of concrete restoration and structural-strengthening products, including repair mortars, epoxy adhesives, construction grouts, waterproofing products, sealers, coatings, thin bonded flexible epoxy overlays and water repellents.

Globally, MAPEI's system solutions have been utilized for bridges, highways, parking garages, stadiums, buildings and other structures.

Visit www.mapei.com for details on all MAPEI products.

1. **Mapecrete™ Protector FF** protective coating*
2. **Mapecrete Hard LI** lithium silicate densifier
3. **Ultratop® PC** or **Ultratop** concrete topping (white or natural gray)
4. Sand broadcast
5. **Planibond® EBA** epoxy bonding agent
6. **Planiseal® MB** moisture control
7. **Planitop® 11** deep-fill repair
8. Trench
9. Concrete subfloor

* To obtain this look, a stain was also applied.



MAPEI USA



27495 2nd Place
Junction City, OR 97448

Presorted Standard
U.S. Postage PAID
Permit No. 39
Lebanon Junction, KY

Sent to you by:

Electronic Service Requested

FREE FREIGHT

ON ALL PROPANE MACHINES

While supplies last. Lift gate and residential deliveries may have additional cost. Please call for details.

V32G-X

V25G-X

L32G-GTX

L30G-GTX

L20G-GTX

L38GR-GTX



LAVINA
by SUPERABRASIVE

Interested In Becoming A Dealer???

Call Us For More Information 1-888-799-CPHQ (2747)

Sales ♦ Support ♦ Rentals ♦ Training ♦ Same Day Shipping

CONCRETE POLISHING HQ

1-888-799-CPHQ (2747)

For more information
email us at orders@cphq.net
or call 1-888-799-CPHQ (2747)
www.ConcretePolishingHQ.com
Se Habla Español!

IN-HOUSE FINANCING!
CALL US FOR MORE INFORMATION
1-888-799-2747

